



BLAZE

OUTDOOR

by



NU-FLAME



Contents

Why choose an outdoor gas fire?	3 - 5
What is the Nu-Flame Blaze Outdoor?	6
Technical	7

Model 8025 shown

*Input:
14.4kW Natural Gas
11.6kW Propane*



Why Choose an Outdoor Gas Fire?

Easy lighting as and when required. No need to fiddle around with kindling and matches, or rely on expensive shop bought fire starter logs.

A quick turn of the valve, whenever the mood takes you, results in instant flames and heat!

Smoke free, clean burning and odourless. You can enjoy a garden party, quiet drinks or dinner without smoke blowing in your eyes or leaving clothes and hair smelling like a camp fire.

No need to place the fire at the end of the garden to avoid smoke billowing into your house! The clean, smoke free, Blaze Outdoor can be placed close to your house and enable the party to continue long into the evening.



The Blaze Outdoor has been developed to allow you to create a unique centrepiece for your garden. It is a versatile burner system around which your designer can create a table to suit your outdoor lifestyle or build a stunning garden feature made from brick, stone or marble.

Nu-Flame has been making innovative indoor gas fires since 1982. In designing the Blaze Outdoor we have brought our wealth of experience to the outdoor area for the first time. Manufactured in our state-of-the-art factory, from high grade stainless steel and finished in exterior architectural quality graphite powder coating, the Blaze Outdoor offers the highest quality and reliability on the market.

The flaming heart of your outdoor living experience.





Our unique burner design gives the most stunningly realistic flame pattern.

Model 4545 shown

Input:

14.9kW Natural Gas

15.84kW Propane

What is the Nu-Flame Blaze Outdoor?

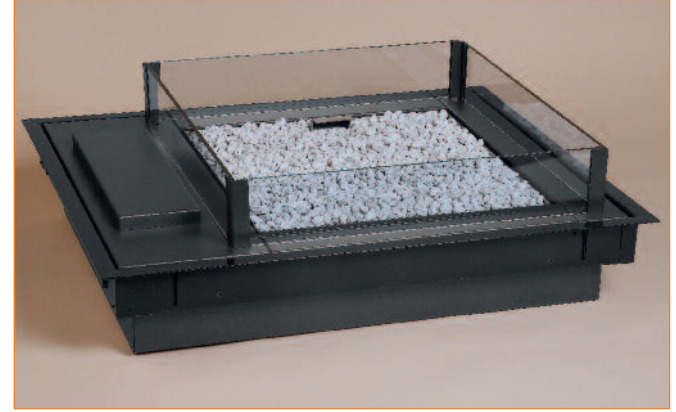
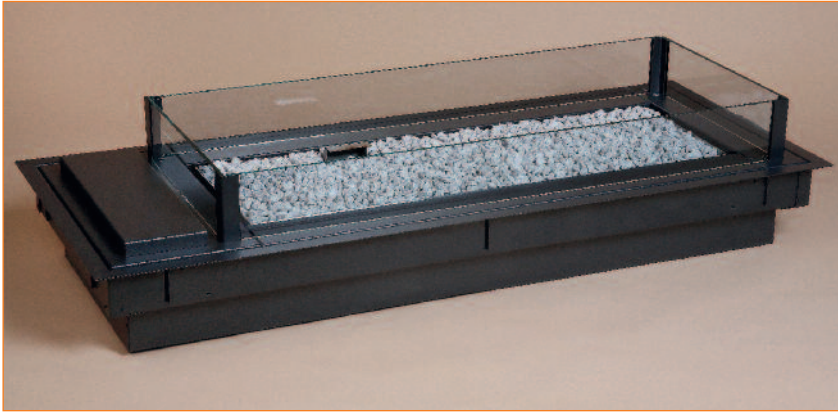

The Blaze Outdoor comes in two standard sizes, the **8025 rectangular burner** and the **4545 square burner**.

It is a fully enclosed and weather proofed module that, with the aid of its unique support cradle, can be sunk into any brickwork, table top, stone or marble feature. The Blaze Outdoor comes with a stunning smoked glass wind shield.

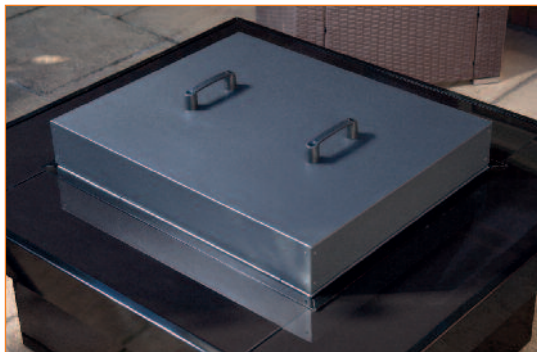

All weather cover supplied as standard.

Natural Gas or Propane



Controls

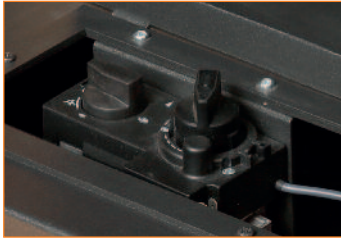

Manual

Available with a manually operated valve as standard.



Optional Handset

After lighting the fire with the manual valve the optional handset allows you to adjust the flame height and switch to pilot only setting simply by pushing a button.

Fuel Bed Options



White Crushed Rock



Logs

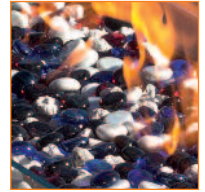

Coloured Beads

8025 Rectangular

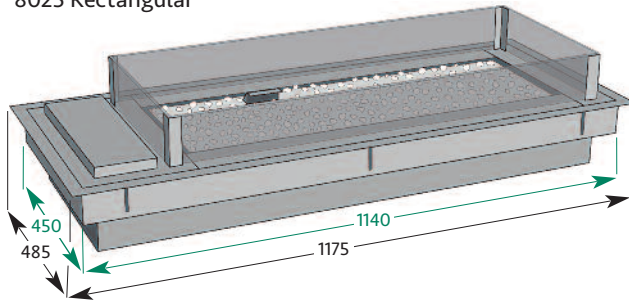

4545 Square

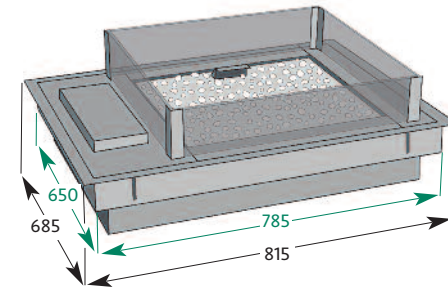

figures in green show cut out size
all measurements in mm





Nu-Flame Ltd.

Unit 4, Kimpton Trade & Business Centre
Minden Road, Sutton, Surrey SM3 9PF

T: 020 8254 6802

Email: sales@nu-flame.co.uk

Web: www.nu-flame.co.uk

Proudly Designed and Manufactured in the UK

