



THE ICONA 600+

**Heater Suitable For Natural Gas at Inlet Pressure 20mbar
or Propane at Inlet Pressure 37mbar**

USE, INSTALLATION & SERVICING INSTRUCTIONS

Important

**A Carbon Monoxide Alarm Complying With BS EN 50201 Must Be Provided
In The Room Where The Gas Fire Is Installed.**

It Must Be Fitted And Maintained In Line With The Manufacturer's Instructions.

All Propane (LPG) Installations Should Be Fitted with a Over Pressure Shut Off Valve (OPSO).

The outer parts of this fire will become hot during use, cloths or combustible items must not be placed close to or on the fire. We recommend that a Fireguard conforming to BS8423 should be used for protection of Young Children the Elderly, Infirm and Pets.

**ALL INSTRUCTIONS MUST BE LEFT WITH THE USER FOR
SAFE KEEPING**

MANUFACTURED by:

Nu-Flame Limited

Unit 4, Kimpton Trade & Business Centre

Minden Road, Sutton, Surrey SM3 9PF

Tel: 020 8254 6802

Fax: 020 8641 9992

Email: sales@nu-flame.co.uk

Country of Destination - GB & IE

CONTENTS

Section No	Subject	Page
User Section		
-	Contents Page	2
-	Box Contents	2
-	Fitting Kit Contents	3
1	User Instructions - Important Notes	4
2	Lighting & Controlling the Fire	5
3	Cleaning the Fire	6
4	Servicing	6
Installation Section		
-	Record Data	6
5	Installation Requirements	7
6	Appliance Data	7
7	Appliance Dimensions	7
8	Trim Styles	8
9	Flue Requirements	8
10	Ventilation	8
11	Gas Supply	9
SECTIONS 13 to 18 Are For The Various Installation Options For WALL MOUNTED TELEVISION Also Refer To Section 19		
12	Site Surveying (It is Recommended to read this Section 1st)	10
13	Installation for Fires with Trims into Class 1 & Lined Flues Builders Enclosure Requirements	11
14	Installation for Trimless Fires into Class 1 & Lined Flues Builders Enclosure Requirements	13
15	Installation for Fires with Trims & Fire Surrounds Builders Enclosure & Fire Surround Requirements	16
16	Installation for Trimless Fires & Fire Surrounds Builders Enclosure & Fire Surround Requirements	19
17	Installation for Fires with Trim into False Chimney Breasts Flue & Hole in the Wall Builders Enclosure Requirements	22
18	Installation for Trimless Fires into False Chimney Breasts Builders Enclosure, Flue & Fire Surround Requirements	26
19	Installation Requirements for Wall Mounted Televisions	30
20	Fitting the Fire	32
21	Arrangement of the Fuel Effect - Logs, Pebbles & Coals	34
22	Testing, Commissioning & Use & Spillage Testing	46
23	Briefing the Customer	47
24	Servicing	47
25	Fault Finding Guide, Symptoms & Possible Cause	48
26a,b,c & d	Energy Class & Product Fiche	50
27a & b	UK & EU Declaration of Conformity	54
28	Diagram of Radio Frequency Control System	56
-	Guarantee	57

BOX CONTENTS

The Fire comes in 1 box containing the Fire with chosen Control and Fitting kit (see next page for fitting kit contents) plus the chosen Fuel Bed Components (Coals or Pebbles). A Trim if ordered may come in a separate box.

THE ICONA 600+ FITTING KIT CONTENTS:

Note: The Icona 600+ as a separate Battery Cassette fitted in the left of the Firebox. Simply slides upward.

Cable Fixing Kit (2 # cables and fittings, 2 Brackets with Screws, 4 # eyebolts, 4 # screws and 4 # plastic plugs).

1 # Firebox Support Bracket Assemblies plus Rawl plugs and Screws.

1 # Flue Restrictor.

1 # Flue Hood (For Convectional Flues the Flue Hood will have been ordered).

or

1 # Flue Canopy (For Liner Flue Applications the Flue Hood will have been ordered).

15 # No.6 x 10mm pointed self tapping screws for the Restrictor, Baffle Assembly, Flue Hood or Canopy.

1 # Baffle Assembly.

1 # Set of Left Hand & Right Hand Metal Firebox Liners.

1# Burner Box Assembly (complete with Burner Tray Assembly).

1# Battery Cassette (at the left, simply pushed in so Slides out Upward, once clear remove Battery Holder and Lead)

4 # Magnets for holding Front Trim on (Note: No Magnets required for Trimless Models).

1# Chosen Trim Style Assembly (Numerous Finishes & Sizes) (Grande trim will have 4 additional Magnets).

1 # 2,100mm length of 6mm x 4mm self adhesive silicone sealing strip.

1 # 10mm Back Nut & olive to connect 8mm copper pipe gas supply to the burner (via the isolation elbow).

1 # Chosen Rear Liner Pack, (Matt Black, Light Board or Slate Wall Effects).

1 # Chosen Trim Assembly (Harmony, Deluxe, Grande or Concept). (No Trim required for Trimless Models).

1 # Fuel Effect Set, Wood Effect (Log effect or Driftwood effect), Pebble Effect or Coal Effect.

1 # Remote Control Handset.

1 # PP3 9 volt Battery for Handset.

4 # AA Batteries for the Battery Box.

1 # Set of Instructions / Warranty.

Optional Extra's for Trimless Fire Installations with Separate Instructions

Edge Kit for Trimless Fires with Surround Back Panels (Covers gap between Inner Wall and Back Panel)

Edge Kit for Trimless Fires (Edge Kit provides a frame around inner edge of Plaster Board to Plaster up to)

Due to the combined thicknesses of the fires flanges, seal and fixings a gap will be present behind the Plaster Board or Fire Surround Back Panel. The Edge Kits are provided to cover these gaps and for Plaster Board applications provide a leading edge to plaster up to.

ICONA 600+

USER INSTRUCTIONS

1. - IMPORTANT NOTES

- a. This appliance must be installed by a properly qualified (in accordance with National & Local Regulations) Installation Engineer.
- b. The connection of this appliance and ventilation requirements (if any) are to be according to National & Local Codes.
- c. For appliance fitted in the UK they do not normally require any purpose provided additional ventilation, however if it has been found necessary to add a vent, (or a vent is fitted as required in IE), periodically check that it is free from obstruction.
- d. Consult all Instructions before Installation and Use.
- e. Do not throw rubbish on, or attempt to burn any materials on this appliance. Any Debris or Foreign Matter must be removed from the fire.
- f. The outer parts of this fire will become hot during use, cloths or combustible items must not be placed close to or on the fire. We recommend that a Fireguard conforming to BS8423 should be used for protection of Young Children the Elderly, Infirm and Pets.
- g. For Fires Installed above floor level, (Hole in the wall Fires), it is recommended that a means, (tactile separator/shelf or guard) is provided to give abrupt warning to a person moving inadvertently towards the fire.
- h. The appliance should be Serviced Annually in accordance with the Gas Safety & Uses Regulations.
- i. Where the flue has been used for Solid Fuel it must be swept before Installation.
- j. If at any time you smell gas or fumes turn the fire off and contact your Installer.
- k. These Instructions must be left with the User for future reference.
- l. During its first period of use any protective coatings and oils will burn out of the appliance and it is wise to ventilate the room for the first hour of use.
- m. This appliance is fitted with an oxygen depletion sensing system, which automatically shuts off the gas supply to the fire if the oxygen level in the room is depleted, due to lack of primary air, or obstructed flue (blocked chimney) that would lead to incomplete combustion of the gas. It must not be tampered with and only replaced with a genuine Nu-Flame ODS.
- n. In the event that the fire shuts down for any reason, attempt to restart it. If there is a continuing problem, call in a properly qualified specialist engineer.
- o. There are no user replaceable parts in the appliance apart from the batteries for the Thermatronic Radio Frequency Electronic Control System.
- p. The Batteries may need to be changed every 6months dependant on usage of the fire.
- q. If any modifications are made to the property, e.g. double glazing addition of extraction fans or anything that could affect ventilation then the Installer should be contacted to have the spillage performance carried out to ensure the fire is clearing its products of combustion.
- r. The chimney should be regularly checked to ensure that all the products of combustion are entering the flue & that there is no build up of soot. If there is, the appliance must be serviced.
- s. Wood, Coal or Pebble fuel effects, manufactured from refractory fibre, are supplied with this appliance. Do not use real wood ,coals or pebbles as this is dangerous. If the simulated fuel bed components need renewing please obtain suitable replacements from a Nu-Flame Stockist. Light coloured Fuel Effect pieces like Pebbles can be prone to discolouration, this is quite normal.
- t. The fire must be installed in accordance with the rules in force and these Instructions it must be installed into a fireplace or builders opening as detailed in these Instructions.
- u. No combustible materials e.g. curtains must be closer than 500mm to the fire.
- v. For Fire Surround/Shelf Applications a 150mm (6") combustible shelf can be fitted above the fire provided it is 150mm above the Fireplace Opening. See Sections 14 or 15 for more detail.
- w. The Fire can be installed into a suitably designed fire surround with a 150°C Rating.
- x. Take care with some Micro Marble Materials claiming a 150 Centigrade Rating as they may give off odours, blister or discolour.
- y. Please note that over time some wall staining will occur above the fire and this is due primarily to particles of dust present in the hot convection air circulating up and over the fire/surround and sticking to the wall.
- z. If a Wall Mounted Television is mounted above the fire you must take account of the Television Manufacturers Instructions. The Installation requirements provided with these Instructions must be adhered to for such installations and are provided to ensure an acceptable ambient temperature is provided above the fire.

It is quite normal for the fire to make popping and burbling sounds when in use, as would a solid fuel fire.

Health & Safety Advice Refractory Ceramic Fibre (RCF) Advice when working with Fuel Bed Components including Installing, Servicing and Disposal.

The Fuel Effect parts and possible Linings of this fire are made from Refractory Ceramic Fibre (R.C.F.) a Class 2 Carcinogen which is a material designed for this Application. Excessive exposure to these types of materials may cause temporary irritation to eyes, skin and respiratory tract. Therefore take care when handling these articles to ensure dust is kept to a minimum. It is not necessary to wear protective clothing when handling these articles but we do recommend you follow the normal hygiene rules of not smoking, eating or drinking in the work area, and always wash your hands before eating or drinking. To minimise the release of RCF fibres during installation and servicing a HEPA filtered vacuum is recommended to remove any dust accumulated in and around the fire both before and after working on it. When Servicing and if replacing these parts we do not recommend they are broken up but are sealed within a heavy duty polythene Bag and labelled as "RCF waste". This is not classified as "hazardous waste" and may be disposed of at a local licensed landfill site.

2. - LIGHTING & CONTROLLING THE FIRE

General

The fire is fitted with a Thermatronic Radio Frequency Electronic Remote Control System (Fire is lit and operated with the Handset).

2.1 - LIGHTING & CONTROLLING THE FIRE - THERMATRONIC RF CONTROL

The Thermatronic Control System is a battery operated gas fire control system that uses a microprocessor to provide the working sequences needed by the fire, and when used with an oxypilot has all the safety features required by law and CE approval. Commands are accepted by the microprocessor when buttons are pressed. An audible beep means that the command is received, and the push button should immediately be released.

Using the System

Important

Control can only be achieved if the Handset is pointed at the Fire. See photo of handset.

a. Ignition

Simultaneously press and hold the start/up red button and the right upper button (linked by line) until a short acoustic signal confirms that the sequence has begun, then release the buttons. The pilot is at the back and visible through the slot in the centre of the fuel bed.

Continuous audible signals confirm that ignition is in progress. When pilot ignition is confirmed the motor will be heard turning to open the valve to maximum flame height – this takes about 30 seconds.

b. Flame Height Adjustment

Press the down small flame button until the flame height is at the desired position. If you try to go beyond the preset low flame minimum height the fire will turn off leaving the pilot burner alight (This is the standby position). You will learn from experience the minimum preset flame height.

c. To relight the fire from the standby position, or to increase the flame height from low flame, simultaneously press the large flame button and lower left button (linked by line). Please note that you can have the flame height anywhere between maximum and preset low. For fine adjustment simply tap the large and small flame buttons up or down.

d. To Switch Off

Press the off button.

Note : Emergency Switch-This facility can only be to turn the fire Off.

If the handset cannot be found and the fire is alight and you need to turn it off you can do this by depressing the small switch at the right front side of the fire. The fire will be hot so take care when doing this.

Very Important : After using the Switch the Fire will only be able to be used if the Switch is pressed back to its original ' I ' position.

So after pressing the switch and turning the fire off ensure you repress the switch to its original ' I ' position. This can be done immediately after pressing the switch off as the fire will go off as soon as the switch is pressed to ' O '.

If the Switch is not reset back to the ' I ' position an audible high pitched continuous bleep will be heard.

Note : You cannot light the fire with this switch you can only light the fire with the handset.

2.2 - GENERAL

IMPORTANT - ONLY CHANGE THE BATTERIES WHEN THE FIRE AS COOLED DOWN

a. Battery replacement is recommended at the beginning of each heating season, and dependant on usage every 6 months or when an acoustic error message sounds during ignition.

b. Error Message – Long signals (0.8 second tone – 0.2 second break) during ignition – probable cause - batteries in electronic receiver box are nearly discharged.

c. Error Message – 5 second continuous tone – probable cause – cable disconnected or on/off switch on valve is in off position

d. Batteries Battery Box within the fire - 4 x AA good quality alkaline.
Handset - 1 x PP3 good quality alkaline

e. To change the Handset battery slide open the plastic panel on the back of the Handset.

f. To change the Batteries in the Battery Box firstly ensure the fire is cold. At the left side of the fuel bed lift off the Small Grille and then slide up the Battery Box by pulling upward with the plastic covered lever. Remove the Battery Box, from its Holder. Slide open the plastic cover to gain access to the batteries. You can detach the lead from the Battery Box to make access easier but remember to re-connect the lead after changing the Batteries. Refit the Battery Box into its Holder and slide it back into the fire and refit the Small Grille.

2.3 - RESETTING THE MERTIK MAXITROL LOGIC CIRCUITS (RADIO FREQUENCY CONTROL)

Note: Resetting of the Control System cannot be carried out by the User.

If a new Handset has been ordered or as can sometimes occur (such as when the Handset buttons are pressed out of sequence) that the fire stops working because the logic circuits get confused the Control System therefore needs to be reset.

In situations like these and if after changing all the batteries as detailed above the Fire still will not light contact your Installer.

Resetting of the Control System can only be carried out by a Qualified Installation Engineer as the Burner Assembly will have to be removed involving disconnection of the Gas Supply.

Note: For the Installation/Service Engineer - Resetting of the Handset & Control System is covered in Section 24.2 page 47.



3. - CLEANING THE FIRE

- a. Allow to cool before cleaning.
- b. The outer surfaces of the fire can be cleaned with a damp cloth and lightly polished with a duster, do **not** use abrasive cleaners.

4. - SERVICING

- a. The fire should be Serviced Annually in accordance with the Gas Safety & Uses Regulations.
- b. This fire contains no User Serviceable Parts apart from the batteries used with the Thermatronic RF Control System. The batteries in both the hand set and battery box (see Section 2.2) should be changed ever season but dependant on usage may need changing every six months.
- c. Servicing must be carried out by a Registered Installer.
- d. For Servicing or Spare Parts contact your Installer quoting the Fire Name, Model and Serial Number, which can be found on the Data Badge. The Data Badge; is located under the small grille on the left side of the fire see Section 2.2 f.
- e. In the event that the fire shuts down due to any reason, attempt to restart it. If there is a continuing problem, call in a properly qualified specialist engineer.
- f. The Matrix pieces in the fire are Moulded Ceramic Fibre components incorporating Silicone Binders and you may notice that they develops cracks during operation. This is natural shrinkage caused by exposure to high temperatures and is quite normal for the material and will in no way affect the operation of the fire.
- g. If any modifications are made to the property, e.g. double glazing addition of extraction fans or anything that could affect ventilation then the Installer should be contacted to have the spillage performance carried out to ensure the fire is clearing its products of combustion and is operating safely.

THE ICONA 600+
INSTALLATION & SERVICING INSTRUCTIONS

RECORD DATA TO BE COMPLETED & KEPT BY USER:

PLACE OF PURCHASE DATE

ADDRESS & TEL. NO.

.....

.....

APPLIANCE SERIAL NO.

INSTALLED BY GAS SAFE REG. NO.

5. - INSTALLATION REQUIREMENTS

THIS APPLIANCE MUST BE INSTALLED AND SERVICED BY A PROPERLY QUALIFIED, (IN ACCORDANCE WITH LOCAL & NATIONAL CODES), INSTALLATION ENGINEER.

It is the Law in the UK that All gas appliances are installed by a competent person in accordance with the GAS SAFETY (INSTALLATION AND USE) REGULATIONS 1998 (As amended), the relevant British Standards for Installation work, Building Regulations, Codes of Practice and these Instructions. In the UK a Registered Installer is deemed competent. In the Republic of Ireland, all Irish Standards, Local Codes and Bord Gais recommendations should be adhered to.

The Installation should also be carried out in accordance with the following where relevant:

1. BS5871 Part 2 2. BS5440 Parts 1 & 2 3. BS6461 Parts 1 & 2 4. BS6891 5. BS8303 6. BS EN 1856 7. BS715
Building Regulations and Standards issued as relevant by the Department of the Environment or the Scottish Development Department.

In the Republic of Ireland Installation should be carried out in accordance with IS813, ICP3, IS327, Building Regulations, Codes of Practice, these Manufacturers Instructions and any Rules In Force.

Particular Reference should be made to the Ventilation Requirements, for the UK this Appliance would not normally require any additional purpose provided ventilation, for the Republic of Ireland ventilation should be in accordance with IS813 Domestic Gas Installations.

Failure to comply with the above could leave the Installer Liable to Prosecution and Invalidate the Warranty.

IMPORTANT

BEFORE PROCEEDING WITH THE INSTALLATION READ THESE INSTRUCTIONS CAREFULLY. THESE INSTRUCTIONS SHOULD BE LEFT WITH THE USER FOR SAFE KEEPING AND FUTURE SERVICING. PRIOR TO INSTALLATION ENSURE THAT THE GAS TYPE AND PRESSURE ARE AS STATED ON THE APPLIANCE DATA BADGE.

6. - APPLIANCE DATA

- a. Gas Type: See Data Plate (Natural Gas at 20mbar or Propane 37mbar).
- b. Burner Pressure: Natural Gas 18.6mbar cold. Propane 36.5mbar cold.
- c. Control Systems: Thermatronic RF (Fully Sequential-Radio Frequency) Control System operated by Handset pointed at Fire.
- d. Fire Safety: Oxygen Depletion & Flame Failure Device.
- e. Ignition: Thermatronic RF-Full Sequential Control.
- f. Inlet Connection: 8mm Compression Fitting to Gas Isolation Elbow.
- g. Categories: I2H & I3P
- h. Injector: Natural Gas (G20) - 480 Multi hole. Propane (G31) - 220 Single hole.
- i. Heat Input: High: Natural Gas (G20) - 7.3kW Gross (6.58kW Net). Propane (G31) - 6.1kW Gross (5.6kW Net).
- j. Heat Input: Low: Natural Gas (G20) - 2.5W Gross (2.25kW Net). Propane (G31) - 2.5Kw Gross (2.3kW Net).
- k. Efficiency Class: 2. The Efficiency of this appliance has been measured as specified in BS7977:1-2009, the results obtained were up to Natural Gas 51.4% Gross (57.0% Net), Propane 50.0% Gross (54.3%Net). The test data has been certified by BSI Group (0086) and can be used in the UK Government's Standard Assessment Procedure (SAP) for Energy Rating of Dwellings.
- l. Heat Output: High: Natural Gas (G20) up to - 3.75kW. Propane (G31) - 3.04kW.
- m. Heat Output: Low: Natural Gas (G20) up to - 1.26kW . Propane (G31) - 1.22kW.
- n. Pilot ODS Type: Natural Gas (G20) or Propane (G31)
- o. Nitrous Oxide (NOx): 130mg/kWh

7. - APPLIANCE DIMENSIONS

7a. - Icona 600+ Dimensions

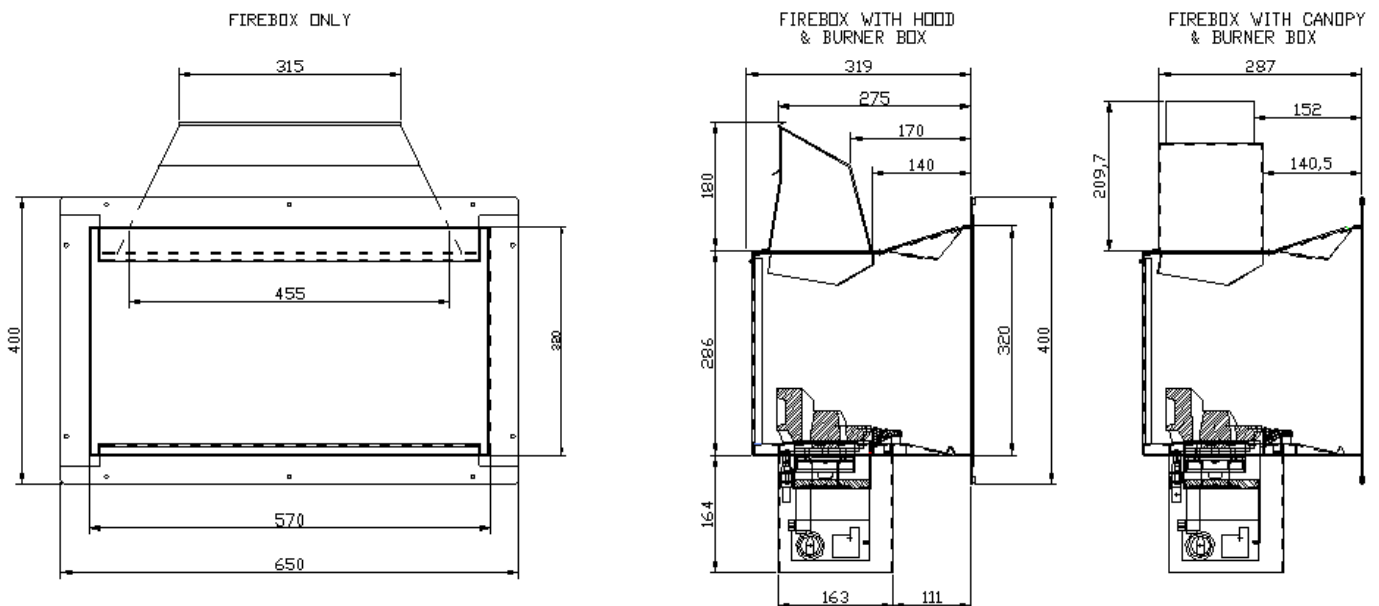

8. - TRIM STYLES

**Note : All trims protrude 21mm from the front of the Fireplace Opening.
Trimless fires do Not use a Trim.**

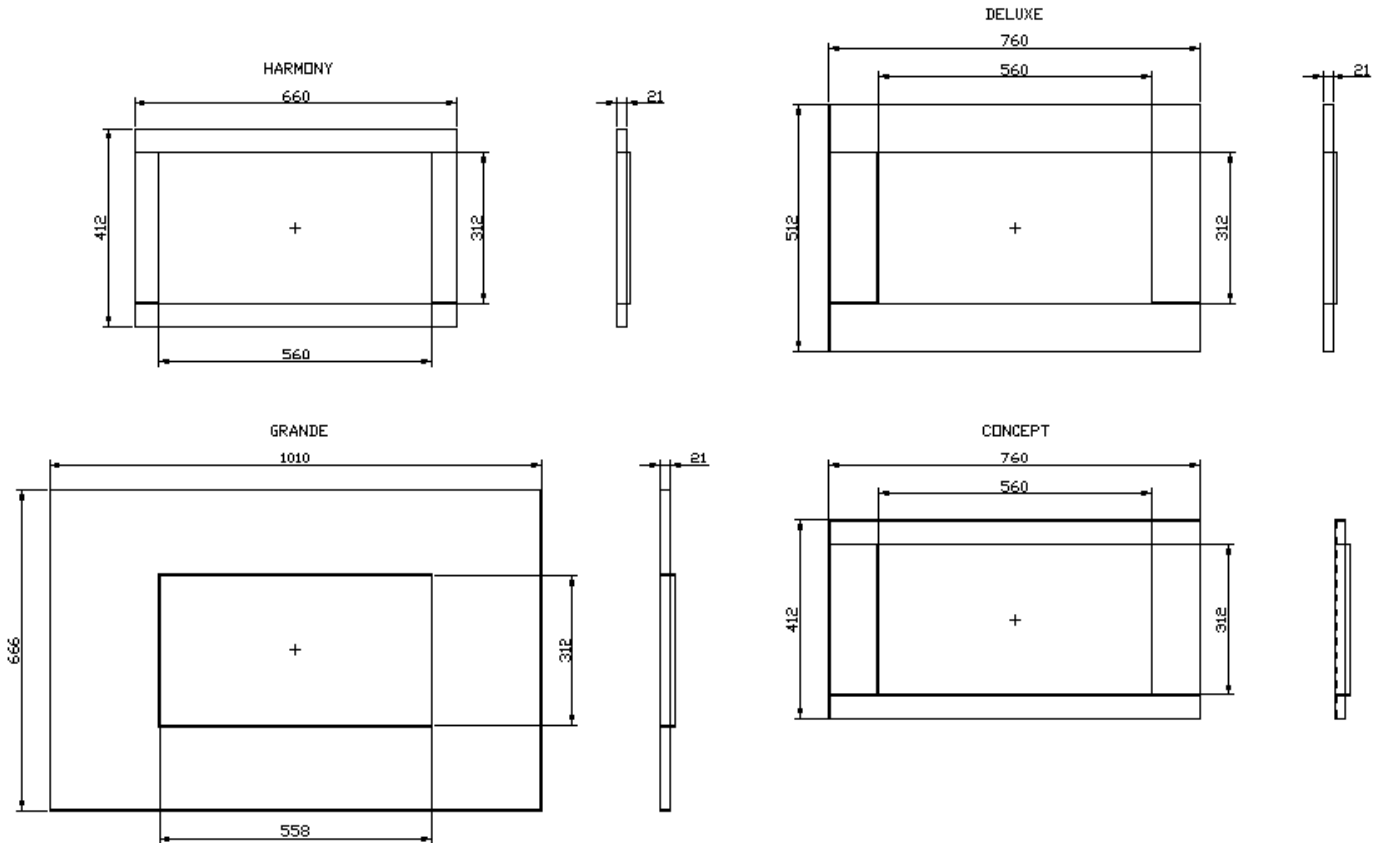

9. - FLUE REQUIREMENTS

These checks MUST be made before constructing the Builders Opening

Note : Not Suitable for Standard Pre-Cast Flues however some Pre-Cast Flues may meet the Minimum Dimensions as Detailed below.

The Appliance is suitable for Installation into the following types of Flue:

- Conventional Stone/Brick Built Flue (Class 1) with a minimum cross sectional dimension of 175mm (7") with a minimum effective height of 3 meters.
- The flue **MUST** be free of any obstructions. Any dampers or restrictors **MUST** be removed. Some dampers are impractical to be removed; therefore they **MUST** be fixed in some way in the **OPEN** position.
- The chimney/flue should be swept if it has been used for solid fuel.
- A Flue Lined with a 125mm (5") Flexible Flue Liner connected to a Register Plate fitted and sealed at the top of the Builders Opening or fitted with the Icona 800 HE Canopy (ordered specially) both options having a minimum effective height of 3 meters.
- For Homes with no Chimney a purpose built and Insulated Enclosure can be constructed (false chimney breast) with a 125mm (5") Flexible Flue Liner connected to the Icona 800 Canopy (ordered specially) fitted and insulated throughout its route and sealed at roof level to a suitable Flue Terminal with a minimum effective height of 3 meters.
- The Fire may be used in conjunction with a Fully Sealed Rebated 150C rated or Equivalent Purpose Built Fire Surround.
- For Pre-cast Flues that are classed as a Class 1 Flue - ensure the walls are dry lined over the route of the flue and no dabs or battens are in direct contact with the flue blocks otherwise wall cracking will occur as detailed in BS 5440 Pt 1 2008.
- A Purpose Designed Flue Box to BS715 fitted with a 125mm (5") twin walled flue with a minimum effect height of 3 meters to BS EN 1856. Details are available from your authorised supplier.
- Ensure that only one fireplace is served by the flue system.
- Ensure that the chimney/flue is continuous from inlet to termination.
- Ensure that the chimney/flue is structurally sound, so that combustion products do NOT come into contact with combustible materials outside the chimney.
- CHECK FLUE PULL.** Before starting any building work apply a smoke match or smoke generator to the flue opening at hearth level and observe smoke. If there is a definite flow into the flue aperture, proceed with installation. If there is not a definite flow into the flue aperture, preheat the flue for approximately 10 minutes and re-test. If there is not a definite flow towards the flue aperture the flue may need attention.

DO NOT FIT THE APPLIANCE, SEEK EXPERT ADVICE.

10. - VENTILATION

- No additional purpose provided ventilation is normally required for the fire when installed in the UK; however this **must** be confirmed by the Spillage Test, see Section 18.2.
- For other Countries refer to National Regulations and Local Codes.
- This appliance is fitted with an oxygen depletion sensing system, which automatically shuts off the gas supply to the fire if the oxygen level in the room is depleted, due to lack of primary air, or obstructed flue that would lead to incomplete combustion of the gas. It **must not** be tampered with and only replaced with a genuine Nu-Flame ODS Pilot.

11. - GAS SUPPLY

Very Important : As Building Work will be required after Installing the Gas Supply Piping Ensure that the Piping or Isolation Elbow is Sealed Off as Dust or Debris will Cause Major Problems.

It Is Recommended to Check The Next Section as Building Work May Affect the Gas Supply Routing.

- a. Carry out a gas soundness test before working on the gas supply.
- b. Gas supply provision should be made in accordance with the latest Gas Safety (Installation and Use) Regulations as amended.
- c. Confirm that the fire has been supplied for the correct gas to be used by checking the Data Badge in the base of the fire.
- d. The Gas Supply Pipe must be routed into the fire as detailed in ' e '. An isolation elbow is provided for the fire to be positioned at the inlet. As mentioned seal off the isolation elbow outlet with for instance tape to prevent dust or debris entering the gas piping.
- e. Your 8mm gas pipe route should be considered before any Building work is planned. A concealed gas supply inlet is provided through the Debris Plate cut out in the base of the Burner Box at the right side of the fire. Route the Gas Pipe at a position of 228mm to the right of the centre line of the fire and 230mm from the front. The Gas Pipe should terminate 25mm below the base of the cut out of the front opening. You will therefore need to determine the position of the base of the Building Opening fire
- f. Where the gas supply passes through walls, floors, voids, concrete and wall cavities the supply should be sleeved.
- g. Determine the gas supply pipe size required taking into account any other gas appliances.
- h. Once the gas pipe fitted and its end position terminated purge the pipe of dust-debris as detailed in ' I ' and fit the 8mm compression isolation/pressure test elbow provided.
- i. In common with all other gas appliances, dirt and debris in the gas system can block the valve and gas injectors on this appliance, and faults caused by this are not covered by the guarantee.
Therefore it is important that all gas pipes **must** be purged of both air and debris.
- j. If you suspect that there may still be dirt and/or debris in the gas system, fit a filter in the pipeline, before the gas isolation/pressure test elbow.
- k. Do **not** use jointing compound on any compression fittings on the fire. The use of jointing compound on the compression joints on this appliance will possibly invalidate the guarantee, as it can get into the control mechanism and cause a malfunction.
- l. Seal off the isolation/pressure test elbow and check all gas connections for gas soundness before proceeding to fit the fire.

! IMPORTANT NOTE ! Always reseal the pressure test point and check that it is gas tight. (This accounts for a lot of recalls.)

IMPORTANT : STUDY THE SITE SURVEYING IN SECTION 12 BEFORE PROCEEDING

***Sections 13 - 17 are for the various Installation Applications -
Only one will apply.***

***! IMPORTANT NOTE ! The chosen installation should have
been predetermined with any parts ordered before any
Building Work Is Started or Installing of the fire.***

The Installation Applications Options Are:

- 13.0 Installation for a Fire with Trim into a Class 1 or Lined Flue - Options:
Shelves both Combustible or Non Combustible.
- 14.0 Installation for a Trimless Fire into a Class 1 or Lined Flue - Options:
Shelves both Combustible or Non Combustible.
- 15.0 Installation for a Fire with Trim into Fire Surround or Slips in a Class 1 or Lined Flue.
- 16.0 Installation for a Trimless Fire into a Fire Surround or Slips in a Class 1 or Lined Flue.
- 17.0 Installation for a Fire with Trim into a False Chimney Breast with 5" Flue - Options:
Fire Surround.
Shelves both Combustible or Non Combustible.
- 18.0 Installation for a Trimless Fire into a False Chimney Breast with 5" Flue - Options:
Fire Surround.
Shelves both Combustible or Non Combustible.
- 19.0 Installation for a Wall Mounted Televisions - With Options Above.

IMPORTANT : ALL RELEVANT SECTIONS SHOULD BE CONSIDERED BEFORE ANY BUILDING WORK.

12. - SITE SURVEYING - SURVEYING THE PROPERTY PRIOR TO INSTALLATION

THE FOLLOWING ARE RECOMMENDATIONS FOR SURVEYING AND ARE IN ADDITION TO THE REQUIREMENTS OF THESE INSTRUCTIONS, NATIONAL STANDARDS AND BUILDING REGULATION REQUIREMENTS.

The following recommendations should be considered to try to avoid problems that will result in issues after the fire has been fitted.

- a)** Downdraught can be a major problem which may result in return visits with problems after the fire has been fitted so:
 - i) Check the geographical position of the property taking account of any known downdraught issues in the area.
 - ii) Check any existing Properties for any special chimney terminals that would indicate downdraught problems.
 - iii) Check any existing fires for signs of downdraught, e.g. discolouration above the fire.
 - iv) Ask the Customer if they ever suffer from wind blowing down the chimney.
- b)** With Pre-cast flues check the following:
 - i) Any signs of walls over heated both on adjoining walls and upstairs. Bring any issues found to the attention of the Customer.
 - ii) Check for any Cracks in the wall above the fire.
 - iii) Check the soundness of any connecting tubes in the loft area.
- c)** Take account of the type, size and height of the chimney when considering the suitability of the fire being considered. For instance if the chimney is quite large or high a higher efficient fire may be more suitable or flue lining may need consideration.
- d)** Take account of the fire previously fitted and enquire if the heat output will be sufficient for the room size and heat requirements of the room.
- e)** Check the condition and soundness of the chimney before proceeding with the installation or any building work.
- f)** Check any wall decoration around the fire for its suitability for withstanding temperatures especially with high efficient fires.
- g)** Take account of the size of the room any large windows ensuring that the fire being considered will provide sufficient heat. Make the Customer aware if you feel a different type of fire would be more suitable.
- h)** Check if the suitability of the Control being considered will meet the Customers requirements, specifically with people with arthritic problems. Consider if a High level or Remote Control System would be more suitable and make the Customer aware of the advantages.
- i)** If an high efficient fire is being considered into an existing fire surround determine if it is a suitable material, for example some micro marble surrounds are prone to discolouration. Check for any signs of discolouration and make the Customer aware of the possible problem.
The fire must only be installed into a fire surround with a (150centigrade rating).
- j)** Carry out a gas soundness check on the current installation prior to Installation.

We would recommend that if you come across known problems in your area that you add them to the above survey points for future reference.

If you are unsure of any aspect of the Installation seek expert advice.

13. - INSTALLATION FOR FIRES WITH TRIMS (Showing Lintel & Shelf Details)

BUILDERS ENCLOSURE REQUIREMENTS

If a Wall Mounted Television is being Considered Also Make Reference to Section 18

It is Important that you read the whole Section before proceeding with any Building Work.

13.1 - WALL COVERINGS

With any form of heating appliance convection air will rise up past the fire carrying particles of dust that will in time result in varying degrees of wall staining. The fire provides an high heat output so we recommend that any wall coverings are best cut back to within 10mm of the flanges of the fire to reduce the transmitting of temperature through the flanges of the fire.

The Trim will then cover both the Fires flanges and the cut back area of the wall covering.

Over time some staining might occur and we therefore suggest due consideration is taken when considering the use of patterned paper around the fire.

Due to the heat output of The Icona 600+ it is not recommended to use blown vinyl wall covering around the fire.

13.2 - CLEARANCES TO SHELVES & COMBUSTIBLE MATERIALS

- A 150mm non combustible or combustible shelf can be fitted above the fire but must be positioned at least 150mm above the builders opening for Trim Styles Harmony, Deluxe, Concept (see Section 8) and at least 180mm for Grande trim style. For deeper shelves they must be raised a further 25mm for every extra 25mm of depth.
- Any combustible sidewall must be at least 275mm from the inside of the Builders/Fireplace Opening.
- With all heating appliances, soft furnishings, decorations and wall coverings may discolour or scorch if placed too close.
- No combustible material, e.g. curtains must be closer than 500mm to the Builders Opening.

Note : If a shelf is placed too close to the trim or opening it may have an adverse effect on the Trim Finish.

13.3 - HOLE IN THE WALL BUILDING ENCLOSURE AND OPENING SIZES FOR FIRES WITH TRIMS

REFERENCE SHOULD BE MADE TO THE DIAGRAMS

BUILDING ENCLOSURE and LINTEL SIZES

- It is recommended that a qualified builder constructs the building enclosure.

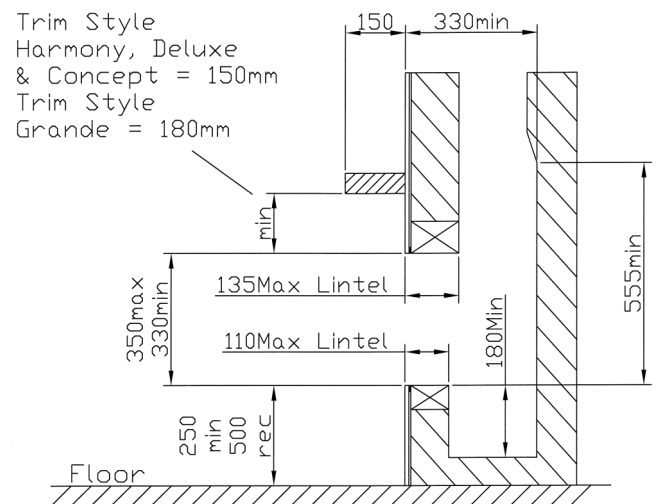
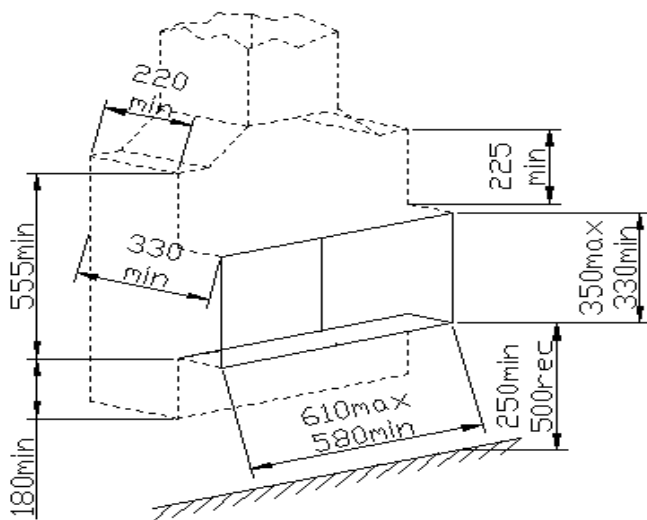

- It is recommended that lintels are used as detailed in the diagrams above structural checks may be required. The diagrams show the maximum sizes of Lintel depth that can be used.

- The Building Enclosure must be constructed of Non-combustible materials.

- No Combustible materials must be present in the Enclosure.

- First determine the preferred bottom position of the Enclosure Opening, we recommend 500mm but the minimum is 250mm.

- If a Wall Mounted Television is being considered then you should also consult Section 15 as this could determine the preferred Height position of the Fire and Enclosure Opening.

- The Base of the Builders Opening must be at least 180mm below the base of the cut out to cater for the sunken Burner System.

- The Builders Opening must be level and between 580mm to 610mm wide and 330mm to 350mm high as shown above.

- The Top of the Builders Opening must extend at least 225mm above the top of the opening to cater for the Hood or Canopy.

- The Enclosure must cater for a minimum depth of 330mm as shown.

- A fully sealed Building Enclosure Must be formed with good mortar joints to ensure the best flue draw is achieved.

TRIM
FLAT AREA REQUIRED
SEE TABLE FOR TRIM STYLES

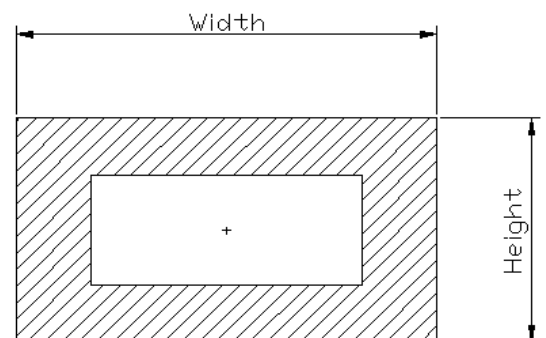

l. A flat area must be left around the opening to cater for the Trim Style ordered.

The sizes required for each trim are:

	Width (mm)	Height (mm)
Harmony trim	670mm	425mm
Deluxe trim	770mm	525mm
Grande trim	1025mm	680mm
Concept trim	770mm	425mm

- m. The Building enclosure should have provision for a gas supply as detailed in Section 11 during construction of the Enclosure.
- n. If plaster board is used to face off the Building Enclosure and it is dry lined to the wall (fixed with plaster dabs) then the air gap between the Plaster Board and the Wall must be sealed off around the cut out. Do not use a foam sealants as this will flow up the gap sealing off the important insulating air gap above the fire, causing the chimney breast to run hot that could affect any wall coverings.

! IMPORTANT ! The Required Opening Sizes are different for a Fire with Trim or Trimless Installation.

! IMPORTANT ! Dry lined walls – ensure that any air gaps between the back of the plasterboard and wall are sealed around the Builders Opening or Fireplace as this can affect flue pull and wall staining, see ' i '.

13.4 - FIXING THE FIREBOX SUPPORT BRACKET ASSEMBLY

We Recommend the use of the Firebox Support Bracket as it is provided to cater for the weight of the Fire when fully Installed with the Burner Box Assembly and Flue Hood or the Flue Canopy dependant on the type of Installation.

- a. One Support Bracket Assembly is provided with the fire for fixing at the rear of the Builders Enclosure. The Support Bracket provides adjustment for Building Enclosure depths up to 345mm deep. For deeper Building Enclosures spacers will be required but they must be made of a non- combustible material..
- b. The top of the Support Brackets should be fixed to the rear of the Builders Opening such that they are level with the base of the Builders Opening.
- c. The fixing should be positioned as shown starting with the lower holes 25mm below the level of the bottom of the Enclosure Opening and the remaining holes as shown. See diagram.

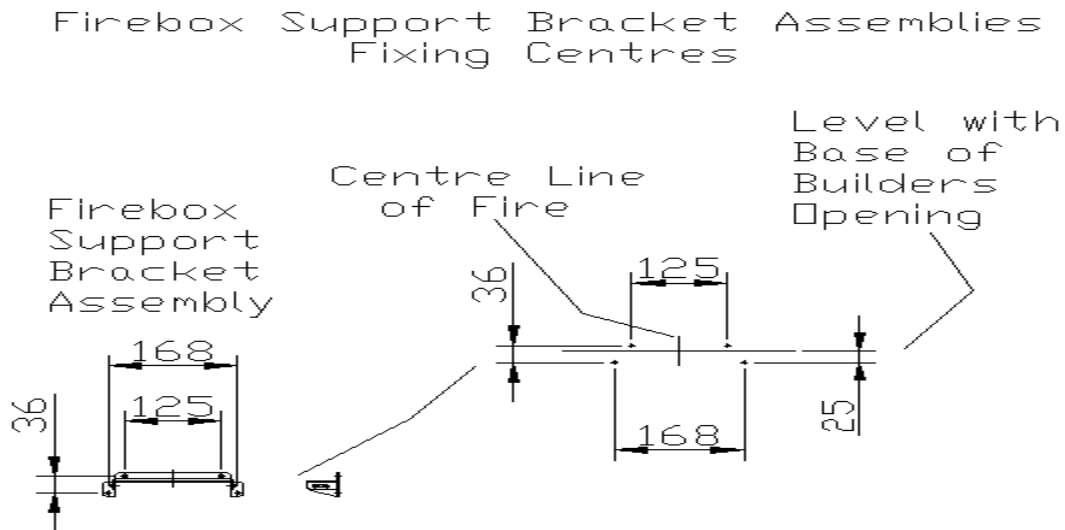

Proceed to Section 20 Fixing the Fire

**14. - INSTALLATION FOR TRIMLESS FIRES (Showing Lintel & Shelf Details)
BUILDERS ENCLOSURE REQUIREMENTS & FITTING THE FIREBOX
The Optional Edge Kit Provides A Frame For Plastering Up To
If a Wall Mounted Television is being Considered Also Make Reference to Section 18**

It is Important that you read the whole Section before proceeding with any Building Work.

14.1 - WALL COVERINGS

With any form of heating appliance convection air will rise up past the fire carrying particles of dust that will in time result in varying degrees of wall staining.

Over time some staining might occur and we therefore suggest due consideration is taken when considering the use of patterned paper around the fire.

Due to the heat output of The Icona 600+ it is not recommended to use blown vinyl wall covering around the fire.

14.2 - CLEARANCES TO SHELVES & COMBUSTIBLE MATERIALS

- a. A 150mm **non combustible** shelf can be fitted above the fire but must be positioned at least 15mm above the Enclosure Opening. For deeper shelves they must be raised a further 25mm for every extra 25mm of depth.
- b. A 150mm **combustible** shelf can be fitted above the fire but must be positioned at least 150mm above the Enclosure Opening. For deeper shelves they must be raised a further 25mm for every extra 25mm of depth.
- c. Any combustible sidewall must be at least 275mm from the inside of the Enclosure Opening.
- d. With all heating appliances, soft furnishings, decorations and wall coverings may discolour or scorch if placed too close.
- e. No combustible material, e.g. curtains must be closer than 500mm to the Enclosure Opening.

14.3 - HOLE IN THE WALL BUILDING ENCLOSURE AND OPENING SIZES FOR TRIMLESS FIRES

REFERENCE SHOULD BE MADE TO THE DIAGRAMS

BUILDING ENCLOSURE, LINTEL SIZES and FLAT AREA REQUIREMENTS

Important : The Building Enclosure will have to be constructed first allowing for the fire to be built-in prior to the front face, i.e. Plaster Board being cut out to cover the fire and flanges and provide the Trimless Style.

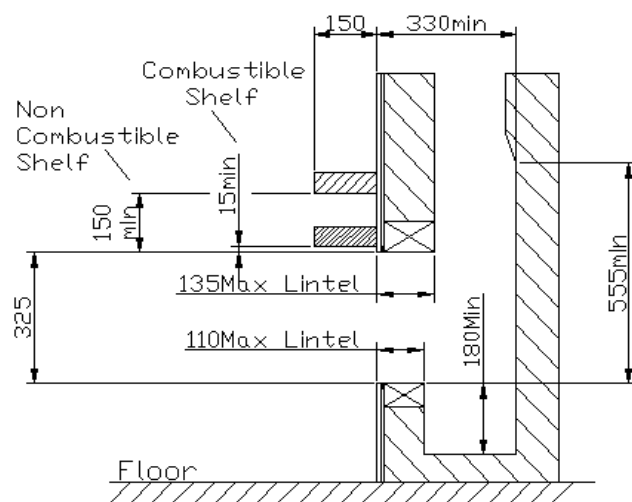
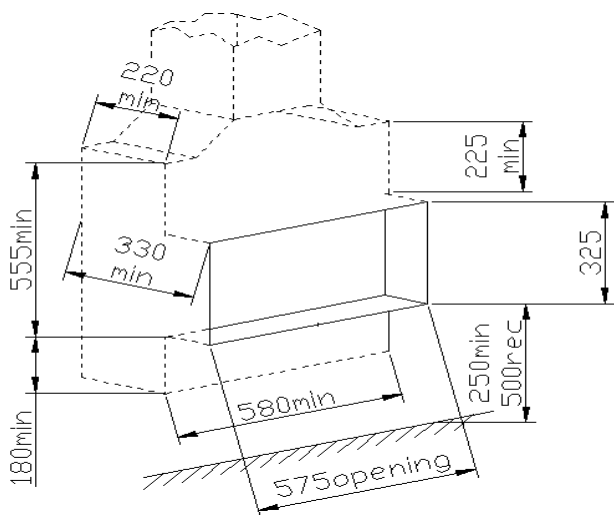

- a. It is recommended that a qualified builder constructs the building enclosure.
- b. It is recommended that lintels are used as detailed in the diagrams above, structural checks may be required. The diagrams show the maximum sizes of Lintel depth that can be used.
- c. The Building Enclosure must be constructed of Non-combustible materials.
- d. No Combustible materials must be present in the Enclosure.
- e. First determine the preferred bottom position of the Enclosure Opening, we recommend 500mm but the minimum is 250mm.
- f. If a Wall Mounted Television is being considered then you should also consult Section 18 as this could determine the preferred Height position of the Fire and Enclosure Opening.
- g. The inner Base of the Building Enclosure Must be at least 180mm below the bottom of the Enclosure Opening to cater for the sunken Burner System.
- h. The Builders Enclosure must be at least 580mm wide to cater for the Firebox, Burner Box System and Flue Hood or Canopy.
- i. The Enclosure must cater for a minimum depth of 330mm as shown.
- j. A fully sealed Building Enclosure Must be formed with good mortar joints to ensure the best flue draw is achieved.
- k. A flat area will have to be provided around the Building Enclosure to ensure the flanges of the Firebox can be sealed.
- l. The Building enclosure should have provision for a gas supply as detailed in Section 11 during construction of the Enclosure.

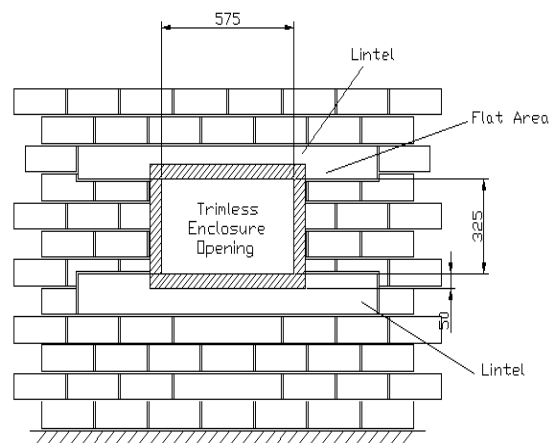

IMPORTANT: The Firebox will now have to be Built-in to the Building Enclosure before the outer plaster board face is applied See 14.5

14.4 - FIXING THE FIREBOX SUPPORT BRACKET ASSEMBLY

We Recommend the use of the Firebox Support Bracket as it is provided to cater for the weight of the Fire when fully Installed with the Burner Box Assembly and Flue Hood or the Flue Canopy dependant on the type of Installation.

- One Support Bracket Assembly is provided with the fire for fixing at the rear of the Builders Enclosure.
The Support Bracket provides adjustment for Building Enclosure depths up to 345mm deep. For deeper Building Enclosures spacers will be required but they must be made of a non-combustible material..
- The top of the Support Brackets should be fixed to the rear of the Builders Opening such that they are level with the base of the Enclosure Opening.
- The fixing should be positioned as shown starting with the lower holes 25mm below the level of the bottom of the Enclosure Opening and the remaining holes as shown. See diagram.

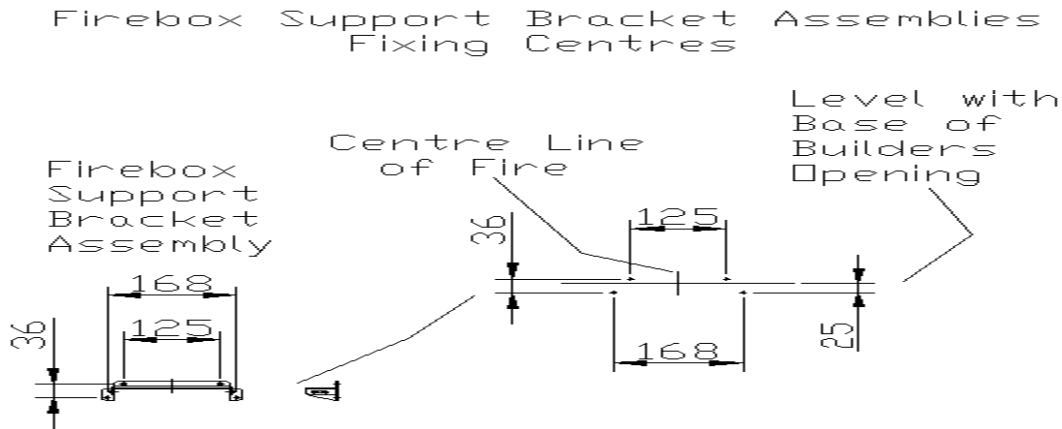

14.5 - FITTING THE FIREBOX (The Optional Edging Kit provides a Frame to Plaster up to)

! IMPORTANT !

Now is a good time to check that the Building Enclosure is to the correct sizes because once the Firebox is Built-in and plastered you will not be able to make any alterations.

- Using a Dust Sheet or equivalent protect the area around the Fire Installation.
- Ensure the Building Enclosure is correctly sized and all building work is sound and dry.
- Remove the Firebox and Parts from the box and identify all the parts to the check list on Page 3.

Important : Now proceed and only remove the parts in the following sequence:

- Remove the Fuel Tray Assembly surrounding the Burner.
- Now working at the left and using the black plastic lever lift upward the Battery Box, disconnect the Battery Lead and set aside.
- Again working at the left side lift up the Battery Cassette Assembly by pulling upward on the tabs inside and set aside.
- Now to the right lift upward and remove the large Burner Box Assembly (complete with Burner Tray Assembly).

- Check that the Gas Supply pipe is in the correct position in the Building Enclosure as detailed in Section 11.
- Lay the Firebox on its front face and apply the high temperature sealing foam around the flanges as shown above.

The Optional Edge Kit 4 part frame should now be made ready for fixing through the Firebox flanges to assist plastering.

Reference to be made to the Instructions supplied with the Edge Kit.

- The Firebox (with edge kit) can be fixed with screws through the flanges, however the Cable Fixing System can also be used. For Cable Fixing See 14.6 before proceeding to 'g'.



! VERY IMPORTANT !

Before Finishing off the Building Enclosure you must now protect the Firebox (also Edge Kit Frame if used).

The inner Painted Surfaces of the Firebox are painted with special paints that could be marked, or damaged during the plastering which is not recoverable. So it is vital that the Opening of the Firebox and edges are masked off before any further building work is started.

If you have used the Optional Edge Kit then protect the inner faces with masking tape or equivalent before plastering.

The Firebox Cardboard Infill piece can be cut down in height to 314mm and held with tape to protect the Firebox paintwork.

Nu-Flame accepts no responsibility for damage caused to the painted surfaces of the Firebox and to replace the Firebox will mean all the Plastering Work will have to be dismantled.

- The Outer Face (e.g. Plaster Board) with the correct sized opening can now be applied.
 - The opening size required is 575mm wide by 325 high and the cut out must be level or slightly below the base opening of the Building Enclosure.
- If plaster board is used we recommend it is dry lined to the wall (glued with dabs) we also make the following recommendation:
 - By using adhesive dabs to fix the Plaster Board it will reduce the temperature conducting through the air gap which will help with any wall covering however ensure the dabs are positioned either side of the route of the flue/chimney.
 - If the Edge Kit as not been used the air gap between the Plaster Board and the Wall must be sealed off around the cut out. Do not use a foam sealants as this will flow up the gap sealing off the important insulating air gap above the fire, causing the chimney breast to run hot which may affect any wall coverings.
 - Using Plaster Board will reduce the drying time.

! VERY IMPORTANT ! The Outer Plaster face must now be allowed to fully dry before proceeding to Fixing the Fire in Section 20.

Proceed to Section 20 Fixing the Fire

14.6 - CABLE FIXING SYSTEM

Reference should be made to the diagrams on the next page.

The cable fixing system will also pull the unit tight back into the Building Enclosure to make a good seal. This is very important to ensure efficient and safe operation of the fire.

See Diagrams Below

The Cable fixing kit consists of , 2 cables, 4 Eye Bolts, 2 Cable Fixing Adjusters, Nuts and Lock Screw and 4 Rawlplugs.

Important : Special High Temperature Rawlplugs have been supplied and must be used.

Details of the Cable Fixing System are as follows:

- i. Working in side the Building Enclosure and with reference to the diagrams, at 5mm below the base of the Building Enclosure drill the 2 lower holes at 520mm centres using a 10mm drill. Dependant on the Enclosure Depth it may be necessary to sink-in the Eye Bolts so before fixing the Rawlplugs chamfer the outer part of the hole.
- ii. Now drill 2 upper holes also at 520mm centres at 265mm above the holes just drilled. Dependant on the Enclosure Depth it may be necessary to sink-in the Eye Bolts so before fixing the Rawlplugs chamfer the outer part of the hole.
- iii. Insert the Rawlplugs and secure the Eye Bolts.

Very Important : Ensure the Eye Bolts are secure as this will affect the flue sealing of the fire which could create an unsafe situation.

- iv. With the 4 Eye Bolts secure and in position you will see two tabs at the top corners of the Firebox. Feed the cables through the tabs. Position the Firebox close to the Enclosure Opening and then feed the 2 cables through the top eye bolt then lower eye bolt in turn. Now slide the Firebox into the Enclosure Opening.
- v. Collect the 2 Cable Fixing Brackets and locate them into the fixing slots in the base of the Firebox on each side as shown and secure with the screw provided.
- vi. Through the opening in the base of the Firebox locate the 2 Cables and each in turn feed through the hole in the Cable Fixing Bracket just fitted. Now collect the 2 Cable Fixing Adjusters and Locking Screws and feed the cable through the Adjuster and Locking Screw. Push the Firebox up against the Enclosure Opening whilst applying tension to the Cable then tighten the Locking Screw onto the Cable. Now tension up the Cable Fixing Adjuster to seal the Firebox to the opening. If any gaps are seen around the Flange of the Firebox they must be sealed with fire cement or high temperature sealant.

CABLE FIXING CENTRES

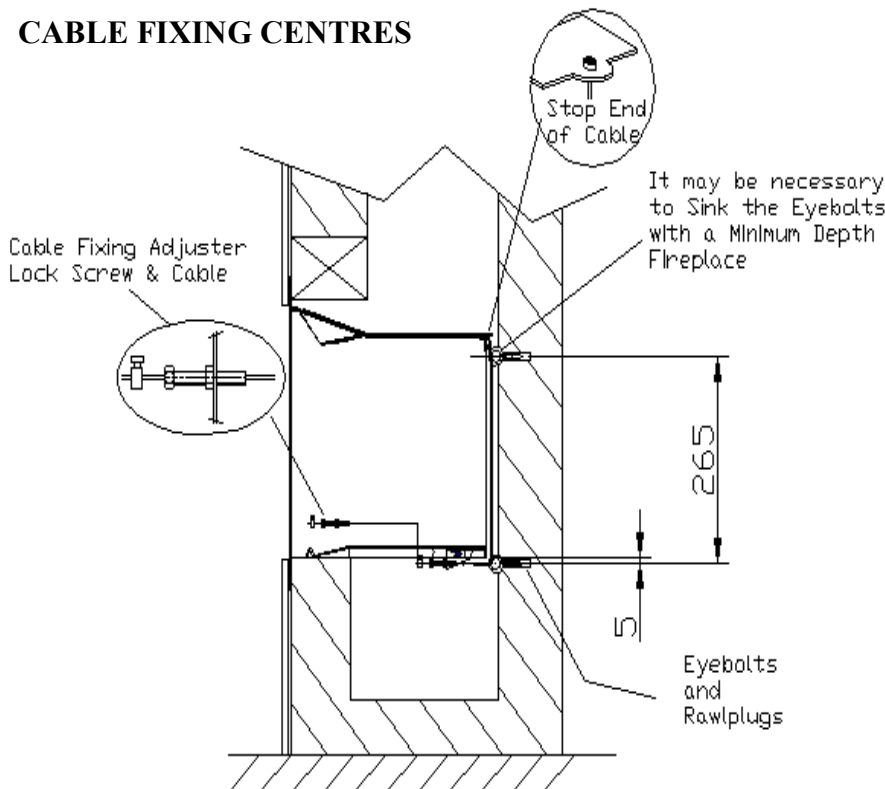

Cable Fixing Bracket

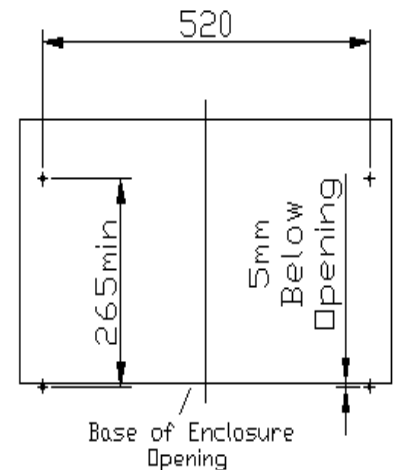

Now Go Back To Section 14:5 ' g ' For The Next Installation Stage.

15. - INSTALLATION FOR FIRES WITH TRIMS & FIRE SURROUND

BUILDING ENCLOSURE REQUIREMENTS & FIRE SURROUND REQUIREMENTS

If a Wall Mounted Television is being Considered Also Make Reference to Section 18

It is Important that you read the whole Section before proceeding with any Building Work.

As a Standard suitable Fire Surround is unlikely to be available a Fire Surround will have to be Purpose Made.

15.1 - FIRE SURROUND or SLIPS REQUIREMENTS - REFERENCE SHOULD BE MADE TO THE DIAGRAMS

- a. Stone, Slate or Marble Fire Surrounds or Slips and/or any adhesives used must have a 150 Degree Centigrade rating. Care should be taken with Micro Marbles claiming to have a 150Centigrade Rating as they can suffer from odour, blistering and discolouration. A Fire Surround consisting of both Combustible and Non Combustible materials can be used, however the following applies:
 - . The Lower Shelf or Hearth below the fire Must always be Non-Combustible.
 - . The Upper Shelf or Mantel above the fire can be either Combustible or Non Combustible, however for Combustible it Must be positioned 150mm above the Enclosure Opening for shelves up to 150mm deep and raised 25mm for every 25mm of extra depth.
 - . Any side members of the Fire Surround can be either Combustible or Non Combustible, however for Combustible they Must be at least 100mm from the Enclosure Opening for depths of up to 100mm deep and moved a further 25mm for every 25mm of extra depth.
- b. The Fire Surround design should take account of the preferred height position of the Fire and Enclosure Opening.
- c. If a Wall Mounted Television is being considered then you should also consult Section 15 as this could determine the preferred Height position of the Fire and Enclosure Opening.
- d. The Fire Surround Back Panel or Slips must cater for a flat area around the opening to cater for the Trim. The minimum sizes required for each trim are detailed below. You may wish to also have a border around the outside of the trim. The Flat Area Sizes Required are shown below. Also those with an 100mm border are also shown below.

	Minimum Flat Sizes for Trims		100mm Border Plus Minimum Flat Sizes for Trims	
	Width (mm)	Height (mm)	Width (mm)	Height (mm)
Harmony Trim	670mm	425mm	870mm	625mm
Deluxe Trim	770mm	525mm	970mm	725mm
Grande Trim	1025mm	880mm	1225mm	880mm
Concept Trim	770mm	425mm	970mm	625mm

- e. There are no limitations on the depth of Fire Surrounds Shelf/Mantel, for Non Combustible Shelf/Mantels however where they are deeper than 150mm and below the minimum position of 150mm above the Enclosure opening they will reduce the Radiant Heat. It is therefore recommended that Natural Materials are used as some Micro Marbles claiming 150 Centigrade Ratings as they can suffer from odour, blistering and discolouration.
- f. Provided the bottom of the Enclosure Opening is at least 250mm above the floor there is no depth requirements for the Fire Surround base/hearth.
- g. If the height above the floor to the Enclosure Opening is reduced below the minimum of 250mm the depth of the Fire Surround base/hearth must be at a minimum of 150mm depth.
- h. The Enclosure must cater for a minimum depth of 330mm as shown.
- i. You can recess both the Fire Surround Hearth/Shelf and Mantel into the wall to provide support, however they must only be let into the wall to the same depth as the Lintels. Lintels must still be used as the Shelf may not provide enough structural support and could crack shortly after Installation or some time in the future if Lintels are not used.
- j. The Fire Surround back panel must be fully sealed to the Enclosure Opening to ensure a good flue seal.

Fire Surround Applications for Icona 600+ with Trims

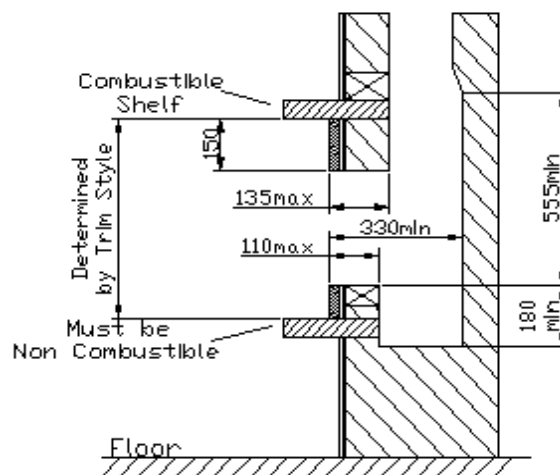

15.2 - WALL COVERINGS

With any form of heating appliance convection air will rise up past the fire carrying particles of dust that will in time result in varying degrees of wall staining. The use of a Fire Surround and or Slips will help to reduce this effect.

- a. A Fire Surround will contain the heat and it is therefore preferable to use a Surround Back Panel or Slips to shield the area between the Enclosure Opening and Fire Surround as any Wall Covering may not withstand the temperatures in this area.
- b. The fire provides an high heat output so we recommend that any wall coverings are best cut back to the outer edges of the Slips or just within the outer edges of the Fire Surround.
- c. Over time some staining might occur and we therefore suggest due consideration is taken when considering the use of patterned paper around the Fire Surround or Slips.

Due to the heat output of The Icona 600+ it is not recommended to use blown vinyl wall covering around the fire.

15.3 - CLEARANCES TO COMBUSTIBLE MATERIALS

- a. Any side members/walls of the Fire Surround can be either Combustible or Non Combustible, however for Combustible they Must be at least 100mm from the Enclosure Opening for depths of up to 100mm deep and moved a further 25mm for every 25mm of extra depth.
- b. With all heating appliances, soft furnishings, decorations and wall coverings may discolour or scorch if placed too close.
- c. No combustible material, e.g. curtains must be closer than 500mm to the Builders Opening.

15.4 - HOLE IN THE WALL BUILDING ENCLOSURE AND OPENING SIZES FOR FIRES WITH TRIMS

- a. It is recommended that a qualified builder constructs the building enclosure.
- b. It is recommended that lintels are used as detailed in the diagrams provided and structural checks may be required.
The diagrams show the maximum sizes of Lintel depth that can be used.
- c. The Building Enclosure must be constructed of Non-combustible materials.
- d. No Combustible materials must be present in the Enclosure.
- e. First determine the preferred bottom position of the Enclosure Opening, we recommend 500mm but the minimum is 250mm.
- f. If a Wall Mounted Television is being considered then you should also consult Section 15 as this could determine the preferred Height position of the Fire and Enclosure Opening.
- g. The Base of the Builders Opening must be at least 180mm below the base of the cut out for the sunken Burner System.
- h. The Builders Opening must be level and between 580mm to 610mm wide and 330mm to 350mm high as shown above.
- i. The Top of the Builders Opening must extend at least 225mm above the top of the opening to cater for the Flue Hood or Canopy.
- j. A fully sealed Building Enclosure Must be formed with good mortar joints to ensure the best flue draw is achieved.
- k. A flat area must be left around the opening to cater for the Trim Style ordered and any border see last Section 14.1 'd'.
- l. If a Fire Surround back panel is used it must be fully sealed to the Enclosure Opening to ensure a good flue seal.
- m. The Building enclosure should have provision for a gas supply as detailed in Section 11 during construction of the Enclosure.
- n. If plaster board is used to face off the Building Enclosure and it is dry lined to the wall (fixed with plaster dabs) then the air gap between the Plaster Board and the Wall must be sealed off around the cut out. Do not use a foam sealants as this will flow up the gap sealing off the important insulating air gap above the fire, causing the chimney breast to run hot that could affect any wall coverings.

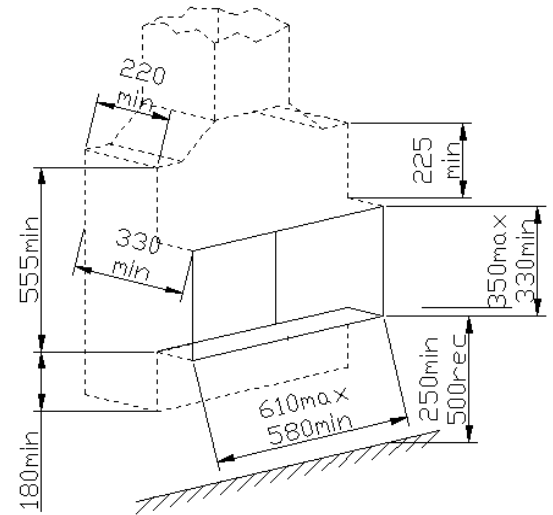

! IMPORTANT ! The Required Opening Sizes are different for a Fire with Trim or Trimless Installation.

! IMPORTANT ! Dry lined walls – ensure that any air gaps between the back of the plasterboard and wall are sealed around the Builders Opening or Fireplace as this can affect flue pull and wall staining, see ' i '.

15.5 - FIXING THE FIREBOX SUPPORT BRACKET ASSEMBLY

We Recommend the use of the Firebox Support Bracket as it is provided to cater for the weight of the Fire when fully Installed with the Burner Box Assembly and Flue Hood or the Flue Canopy dependant on the type of Installation.

- a. One Support Bracket Assembly is provided with the fire for fixing at the rear of the Builders Enclosure.
The Support Bracket provides adjustment for Building Enclosure depths up to 345mm deep. For deeper Building Enclosures spacers will be required but they must be made of a non- combustible material..
- b. The top of the Support Brackets should be fixed to the rear of the Builders Opening such that they are level with the base of the Builders Opening.
- c. The fixing should be positioned as shown starting with the lower holes 25mm below the level of the bottom of the Enclosure Opening and the remaining holes as shown. See diagram.

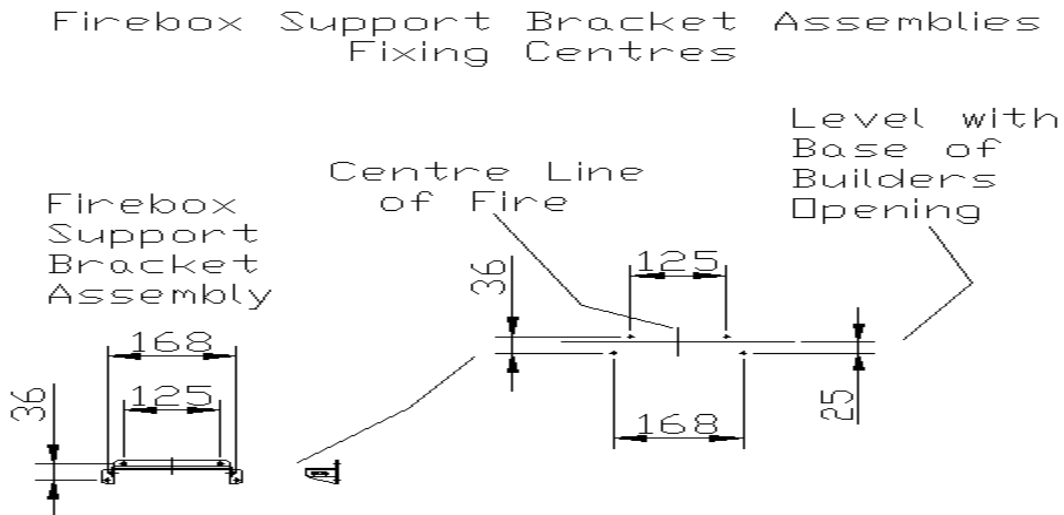

Proceed to Section 20 Fixing the Fire

BUILDING ENCLOSURE, LINTEL SIZES and FLAT AREA REQUIREMENTS

Important : The Building Enclosure will have to be constructed first allowing for the fire to be built-in prior to the front face, i.e. Plaster Board being cut out to cover the fire and flanges and provide the Trimless Style.

a. It is recommended that a qualified builder constructs the building enclosure.

REFERENCE SHOULD BE MADE TO THE DIAGRAMS ON THE PREVIOUS PAGE

b. It is recommended that lintels are used as detailed in the diagrams above, structural checks may be required.

The diagrams show the maximum sizes of Lintel depth that can be used.

c. The Building Enclosure must be constructed of Non-combustible materials.

d. No Combustible materials must be present in the Enclosure.

e. First determine the preferred bottom position of the Enclosure Opening, we recommend 500mm but the minimum is 250mm.

f. If a Wall Mounted Television is being considered then you should

also consult Section 15 as this could determine the preferred

Height position of the Fire and Enclosure Opening.

g. The inner Base of the Building Enclosure Must be at least 180mm

below the bottom of the Enclosure Opening to cater for the

sunken Burner System.

h. The Builders Enclosure must be at least 580mm wide to cater for

the Firebox, Burner Box System and Flue Hood or Canopy.

i. The Enclosure must cater for a minimum depth of 330mm as shown.

j. The Top of the Builders Opening must be at least 225mm above the

top of the proposed opening or 555mm measured from the

base of the proposed opening to cater for the Hood or Canopy.

k. A fully sealed Building Enclosure Must be formed with good mortar

joints to ensure the best flue draw is achieved.

l. A flat area will have to be provided around the Building Enclosure to

ensure the flanges of the Firebox can be sealed, see diagram.

m. The opening sizes in the Enclosure and Fire Surround Back Panel

must be 575mm wide by 325 high from the base of the Enclosure .

n. The Building enclosure should have provision for a gas supply as

detailed in Section 11 during construction of the Enclosure.

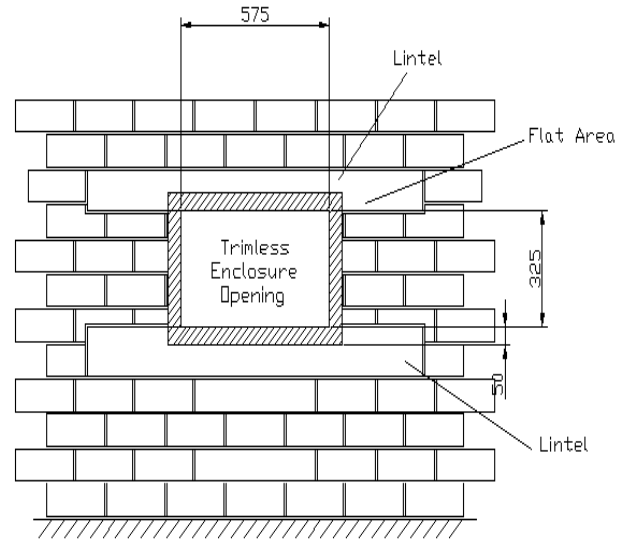

IMPORTANT: The Firebox will now have to be Built-in to the Building Enclosure before the outer plaster board face is applied
See 16.6

16.5 - FIXING THE FIREBOX SUPPORT BRACKET ASSEMBLY

We Recommend the use of the Firebox Support Bracket as it is provided to cater for the weight of the Fire when fully Installed with the Burner Box Assembly and Flue Hood or the Flue Canopy dependant on the type of Installation.

a. One Support Bracket Assembly is provided with the fire for fixing at the rear of the Builders Enclosure.

The Support Bracket provides adjustment for Building Enclosure depths up to 345mm deep. For deeper Building Enclosures

spacers will be required but they must be made of a non- combustible material..

b. The top of the Support Brackets should be fixed to the rear of the Builders Opening such that they are level with the base of the Enclosure Opening.

c. The fixing should be positioned as shown starting with the lower holes 25mm below the level of the bottom of the Enclosure Opening and the remaining holes as shown. See diagram.

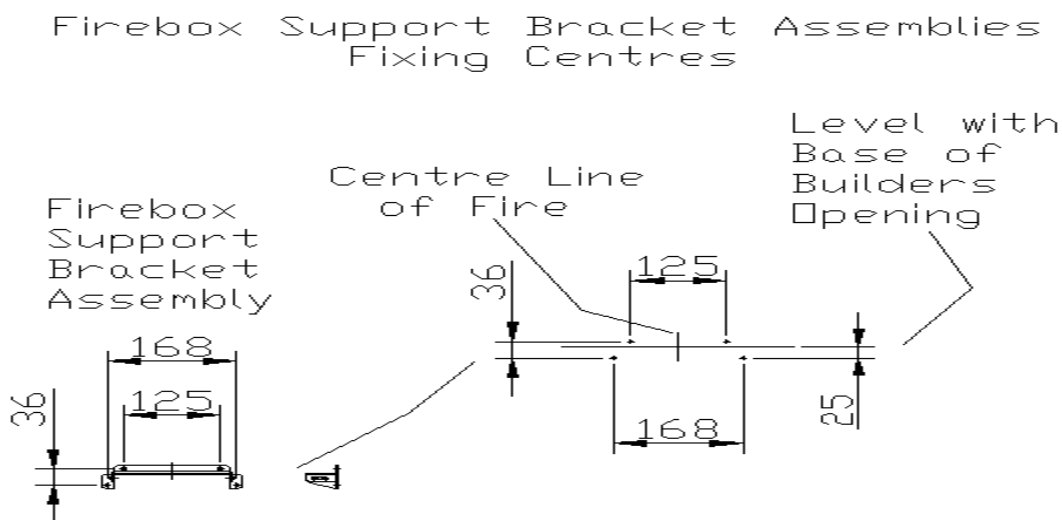

16.6 - FITTING THE FIREBOX

(The Optional Edging Kit covers the gap between the Inner Wall and Surround Panel)

! IMPORTANT !

Now is a good time to check that the Building Enclosure is to the correct sizes because once the Firebox is Built-in and plastered you will not be able to make any alterations.

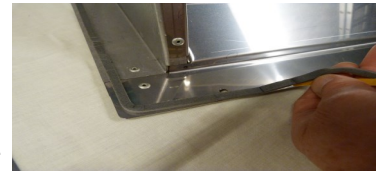

- a. Using a Dust Sheet or equivalent protect the area around the Fire Installation.
- b. Ensure the Building Enclosure is correctly sized and all building work is sound and dry.
- c. Remove the Firebox and Parts from the box and identify all the parts to the check list on Page 3.

Important : Now proceed and only remove the parts in the following sequence:

- i) Remove the Fuel Tray Assembly surrounding the Burner.
 - ii) Now working at the left and using the black plastic lever lift upward the Battery Box, disconnect the Battery Lead and set aside.
 - iii) Again working at the left side lift up the Battery Cassette Assembly by pulling upward on the tabs inside and set aside.
 - iv) Now to the right lift upward and remove the large Burner Box Assembly (complete with Burner Tray Assembly).
- c. Remove the Firebox and Parts from the box and identify all the parts to the check list on Page 3.
 - d. Check that the Gas Supply pipe is in the correct position in the Building Enclosure as detailed in Section 11.
 - e. Lay the Firebox on its front face and apply the high temperature sealing foam around the flanges as shown above.
- The Optional Edge Kit four part frame should now be made ready for fixing through the Firebox flanges.**
- Reference to be made to the Instructions supplied with the Edge Kit.**
- f. The Firebox (with edge kit) can be fixed with screws through the flanges, however the Cable Fixing System can also be used. For Cable Fixing See 13.6 before proceeding to ' g '.
 - g. Screw the Firebox to the enclosure through the holes in the flanges.

Now Choose The Fire Surround Option 'A' or 'B' That Best Fits With Your Application

(This will have depended on how much building work has been necessary to create the Building Enclosure)

A For Installations Where The Surround Back Panel Is To Face Off The Enclosure

- . If a suitably sized enclosure exists or it has been possible to cut out the enclosure and therefore the Surround Back Panel is now to be used to provide the correct sized front opening then plastering will not be necessary as detailed below and the remainder of the Firesurround can therefore be fitted.
- . If the Optional Edge Kit has not been used then there will be a gap between the back of the Fire Surround Back panel and the fire. The gap **must** be sealed off around the cut out with a suitable high temperature sealant. We do not recommend the use of a foam sealant for this application as this will flow up the gap sealing off the insulating air gap between the inner wall and the Fire Surround Back panel causing it to run hot when the fire is in operation.

Proceed to Section 20 Fixing the Fire

B For Installations Where The Enclosure Is To Be Plaster Boarded (or equivalent) Before A Fire Surround Is Fitted

! VERY IMPORTANT !

Before Finishing off the Building Enclosure you must now protect the Firebox (also Edge Kit Frame if used) .

The inner Painted Surfaces of the Firebox are painted with special paints that could be marked, or damaged during the plastering which is not recoverable. So it is vital that the Opening of the Firebox and edges are masked off before any further building work is started.

If you have used the Optional Edge Kit then protect the inner faces with masking tape or equivalent before plastering.

The Firebox Cardboard Infill piece can be cut down in height to 314mm and held with tape to protect the Firebox paintwork

Nu-Flame accepts no responsibility for damage caused to the painted surfaces of the Firebox and to replace the Firebox will mean all the Plastering Work will have to be dismantled.

- h. The Outer Face (e.g. Plaster Board) with the correct sized opening can now be applied.
 - . The opening size required is 575mm wide by 325 high and the cut out must be level or slightly below the base opening of the Building Enclosure.
- i. If plaster board is used we recommend it is dry lined to the wall (glued with dabs) we also make the following recommendation:
 - . By using adhesive dabs to fix the Plaster Board it will reduce the temperature conducting through the air gap which will help with any wall covering however ensure the dabs are positioned either side of the route of the flue/chimney.
 - . If the Optional Edge Kit has been used then by using Dabs for the plaster board the leading edge of the metal frame of the Edge Kit can be positioned to provide an edge to allow for the plaster finish.
 - . If the Optional Edge Kit has not been used then there will be a gap between the back of the Fire Surround Back panel and the fire. The gap **must** be sealed off around the cut out with a suitable high temperature sealant. We do not recommend the use of a foam sealant for this application as this will flow up the gap sealing off the insulating air gap between the inner wall and the Fire Surround Back panel causing it to run hot when the fire is in operation.
 - . Using Plaster Board will reduce the drying time.

! VERY IMPORTANT ! The Outer Plaster face must now be allowed to fully dry before proceeding to Fixing the Fire.

Proceed to Section 20 Fixing the Fire

16.7 - CABLE FIXING SYSTEM

Reference should be made to the diagram below.

The cable fixing system will also pull the unit tight back into the Building Enclosure to make a good seal. This is very important to ensure efficient and safe operation of the fire.

See Diagrams Below

The Cable fixing kit consists of, 2 cables, 4 Eye Bolts, 2 Cable Fixing Adjusters, Nuts and Lock Screw and 4 Rawlplugs.

Important : Special High Temperature Rawlplugs have been supplied and must be used.

Details of the Cable Fixing System are as follows:

- i. Working in side the Building Enclosure and with reference to the diagrams, at 5mm below the base of the Building Enclosure drill the 2 lower holes at 520mm centres using a 10mm drill. Dependant on the Enclosure Depth it may be necessary to sink-in the Eye Bolts so before fixing the Rawlplugs chamfer the outer part of the hole.
- ii. Now drill 2 upper holes also at 520mm centres at 265mm above the holes just drilled. Dependant on the Enclosure Depth it may be necessary to sink-in the Eye Bolts so before fixing the Rawlplugs chamfer the outer part of the hole.
- iii. Insert the Rawlplugs and secure the Eye Bolts.

Very Important : Ensure the Eye Bolts are secure as this will affect the flue sealing of the fire which could create an unsafe situation.

- iv. With the 4 Eye Bolts secure and in position you will see two tabs at the top corners of the Firebox. Feed the cables through the tabs. Position the Firebox close to the Enclosure Opening and then feed the 2 cables through the top eye bolt then lower eye bolt in turn. Now slide the Firebox into the Enclosure Opening.
- v. Collect the 2 Cable Fixing Brackets and locate them into the fixing slots in the base of the Firebox on each side as shown and secure with the screw provided.
- vi. Through the opening in the base of the Firebox locate the 2 Cables and each in turn feed through the hole in the Cable Fixing Bracket just fitted. Now collect the 2 Cable Fixing Adjusters and Locking Screws and feed the cable through the Adjuster and Locking Screw. Push the Firebox up against the Enclosure Opening whilst applying tension to the Cable then tighten the Locking Screw onto the Cable. Now tension up the Cable Fixing Adjuster to seal the Firebox to the opening. If any gaps are seen around the Flange of the Firebox they must be sealed with fire cement or high temperature sealant.

CABLE FIXING CENTRES

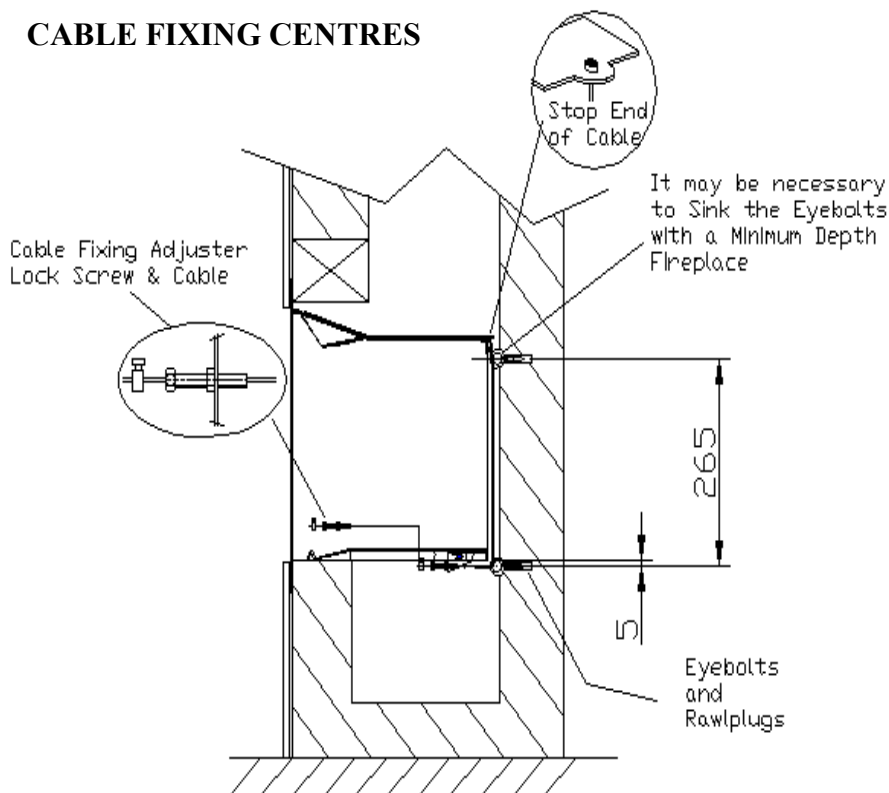

Cable Fixing Bracket

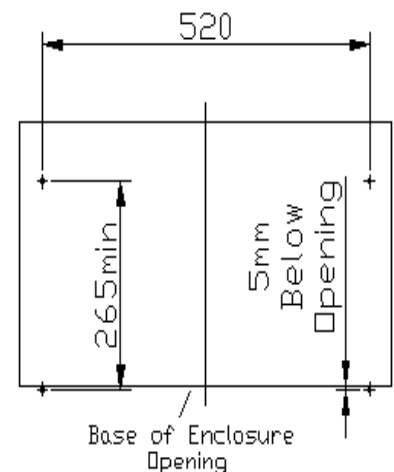

Now Go Back To Section 16:6 ' h ' For The Next Installation Stage.

17. - INSTALLATION FOR FIRES WITH TRIMS INTO FALSE CHIMNEY BREAST WITH A TWIN WALLED 125mm (5") FLUE - ENCLOSURE BUILDING REQUIRMENTS If a Wall Mounted Television is being Considered Also Make Reference to Section 18

It is Important that you read the whole Section before proceeding with any Building Work.

17.1 - WALL COVERINGS

All Wall Coverings or Combustible Cladding Must be removed from the wall where the False Chimney Breast will be sited. With any form of heating appliance convection air will rise up past the fire carrying particles of dust that will in time result in varying degrees of wall staining. The fire provides an high heat output so we recommend that any wall coverings are best cut back to within 10mm of the flanges of the fire to reduce the transmitting of temperature through the flanges of the fire.

The Trim will then cover both the Fires flanges and the cut back area of the wall covering.

Over time some staining might occur and we therefore suggest due consideration is taken when considering the use of patterned paper around the fire.

Due to the heat output of The Icona 600+ it is not recommended to use blown vinyl wall covering around the fire.

17.2 - CLEARANCES TO SHELVES & COMBUSTIBLE MATERIALS

- a. A 150mm **non combustible or combustible** shelf can be fitted above the fire but must be positioned at least 150mm above the builders opening for Trim Styles Harmony, Deluxe, Concept (see Section 8) and at least 180mm for Grande trim style. For deeper shelves they must be raised a further 25mm for every extra 25mm of depth.
- b. Any combustible sidewall must be at least 275mm from the inside of the Builders/Fireplace Opening.
- c. With all heating appliances, soft furnishings, decorations and wall coverings may discolour or scorch if placed too close.
- d. No combustible material, e.g. curtains must be closer than 500mm to the Builders Opening.

Note : If a shelf is placed too close to the trim or opening it may have an adverse effect on the Trim Finish.

17.3 - FALSE CHIMNEY BREAST ENCLOSURE CONSTRUCTION

REFERENCE SHOULD BE MADE TO THE DIAGRAMS

FALSE CHIMNEY BREAST ENCLOSURE

Very Important : The False Chimney Breast Studding Structure can be constructed and enclosed but the plaster board must be left off to the side or where possible to allow for connection of the Flue System.

- a. All Wall Coverings or Combustible Cladding Must be removed from the wall where the False Chimney Breast will be sited.
- b. It is recommended that a qualified person constructs the building enclosure.
- c. The Building Enclosure should be constructed with Studding and Must be lined with 12mm thick Non Combustible board, e.g. Superlux Board or equivalent as shown in the diagram and as detailed below:
 - . The 12mm thick Non Combustible lining must extend to a height of 500mm from the Base of the Opening at back and front.
 - . The 12mm thick Non Combustible lining must extend down below the base of the opening at the back by 100mm.
 - . The Supporting Base at the front Must be lined with 12mm thick Non Combustible Board both on top where the fire will sit and on the inner face.
 - . The Sides of the Enclosure Must also be lined with 12mm thick Non Combustible material.
 - . To create the opening size required within the sizes shown below, fix Strips of 12mm thick Non Combustible Board by 45mm wide around the opening. This will allow the Firebox and Flue Canopy to be Installed ready for connecting the flue.

Fire With Trim Installation

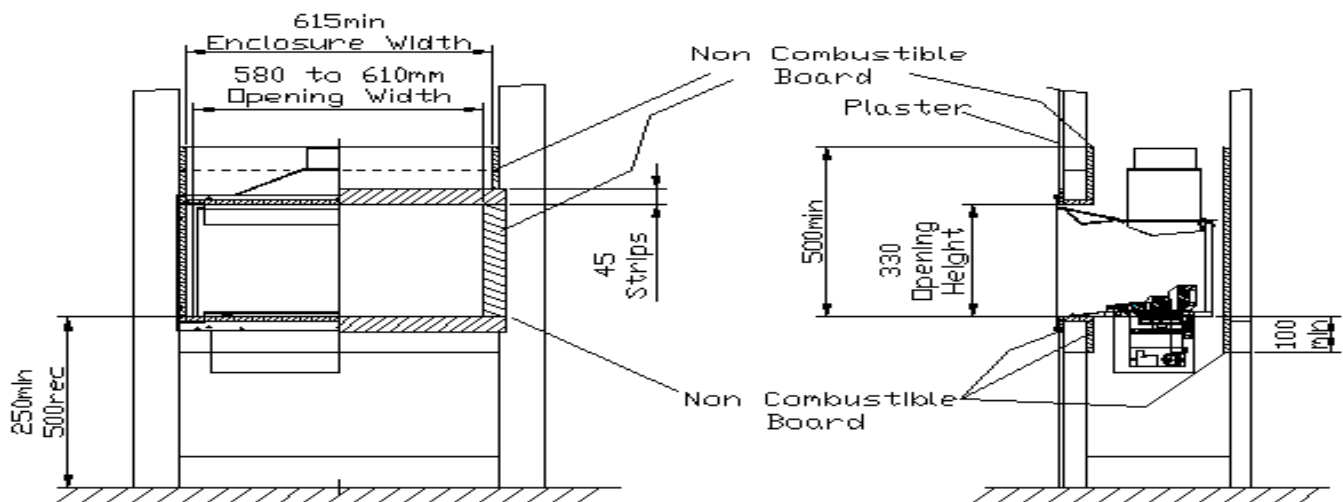

- d. The diagram show the sizes of the Building Enclosure and Enclosure Opening.
- e. No Combustible materials must be present in the Enclosure.
- f. First determine the preferred bottom position of the Enclosure Opening, we recommend 500mm but the minimum is 250mm, however for the minimum height the Enclosure base, sides, back and front must be fully lined down to the base.
- g. Any Fire Surround design should take account of the preferred height position of the Fire and this will affect the position of the Enclosure Base, also see 'I' and the depth required.
- h. If a Wall Mounted Television is being considered then you should also consult Section 18 as this could determine the preferred Height position of the Fire and Enclosure Opening.

- i. The Inner Base of the Builders Enclosure must be at least 180mm below the base of the cut out to cater for the sunken Burner System.
- j. The Enclosure Opening must be level and between 580mm to 610mm wide and 330mm to 350mm high as shown above.
- k. A flat area must be left around the opening to cater for the Trim/Frame Style ordered and allowance will be required for any Fire Surround Back Panel or Slips. You will also need to cater for a border around the outside of the trim.

The Flat Area Sizes Required are shown below for each Trim/Frame. Also the typical sizes with a 100mm border are shown below.

	Minimum Flat Sizes for Trims		100mm Border Plus Minimum Flat Sizes for Trims	
	Width (mm)	Height (mm)	Width (mm)	Height (mm)
Harmony Trim	670mm	425mm	870mm	625mm
Deluxe Trim	770mm	525mm	970mm	725mm
Grande Trim	1025mm	880mm	1225mm	880mm
Concept Trim	700mm	425mm	970mm	625mm

- l. If a Fire Surround is being considered it may have to be Purpose Made and designed see . I .
- m. Slate or Marble Fire Surrounds or Slips and/or any adhesives used must have a 150 Degree Centigrade rating. Care should be taken with Micro Marbles claiming to have a 150Centigrade Rating as they can suffer from odour, blistering and discolouration. A Fire Surround consisting of both Combustible and Non Combustible materials can be used, however the following applies:
 - . The Lower Shelf or Hearth below the fire Must always be Non-Combustible.
 - . The Upper Shelf or Mantel above the fire can be either Combustible or Non Combustible, however for Combustible it Must be positioned 150mm above the Enclosure Opening for shelves up to 150mm deep and raised 25mm for every 25mm of extra depth.
 - . Any side members of the Fire Surround can be either Combustible or Non Combustible, however for Combustible they Must be at least 100mm from the Enclosure Opening for depths of up to 100mm deep and moved a further 25mm for every 25mm of extra depth.
 - . If Non Combustible the Upper Shelf-Top , Sides and Hearth-Base of the Fire Surround can be within 15mm of the Enclosure Opening.
- n. Any Fire Surround back panel must be fully sealed to the Enclosure Opening after plastering to ensure a good flue seal and have opening sizes as detailed in ' j '.
- o. There are no limitations on the depth of Fire Surrounds Shelf/Mantel, for Non Combustible Shelf/Mantels however where they are deeper than 150mm and below the minimum position of 150mm above the Enclosure opening they will reduce the Radiant Heat. It is therefore recommended that Natural Materials are used as some Micro Marbles claiming 150 Centigrade Ratings as they can suffer from odour, blistering and discolouration.
- p. Provided the bottom of the Enclosure Opening is at least 250mm above the floor there is no depth requirements for a Fire Surround base/hearth.
- q. If the height above the floor to the Enclosure Opening is reduced below the minimum of 250mm the depth of the Fire Surround base/hearth must be at a minimum of 150mm depth.
- r. The Flue Manufacturers Installation Instructions Must also be followed for this Installation.
- s. The Building Enclosure should have provision for a gas supply as detailed in Section 11 during construction of the Enclosure.
- t. We recommend that the False Chimney Breast is ventilated at both top and bottom to keep the structure cool.

IMPORTANT : The following stages must now be carried out before the front of the False Chimney Breast is fully enclosed.

17.4 - FIXING THE FIREBOX SUPPORT BRACKET ASSEMBLY

We Recommend the use of the Firebox Support Bracket as it is provided to cater for the weight of the Fire when fully Installed with the Burner Box Assembly and Flue Hood or the Flue Canopy dependant on the type of Installation.

- a. One Support Bracket Assembly is provided with the fire for fixing at the rear of the Builders Enclosure. The Support Bracket provides adjustment for Building Enclosure depths up to 345mm deep. For deeper Building Enclosures spacers will be required but they must be made of a non- combustible material..
- b. The top of the Support Brackets should be fixed to the rear of the Builders Opening such that they are level with the base of the Enclosure Opening.
- c. The fixing should be positioned as shown starting with the lower holes 25mm below the level of the bottom of the Enclosure Opening and the remaining holes as shown. See diagram.

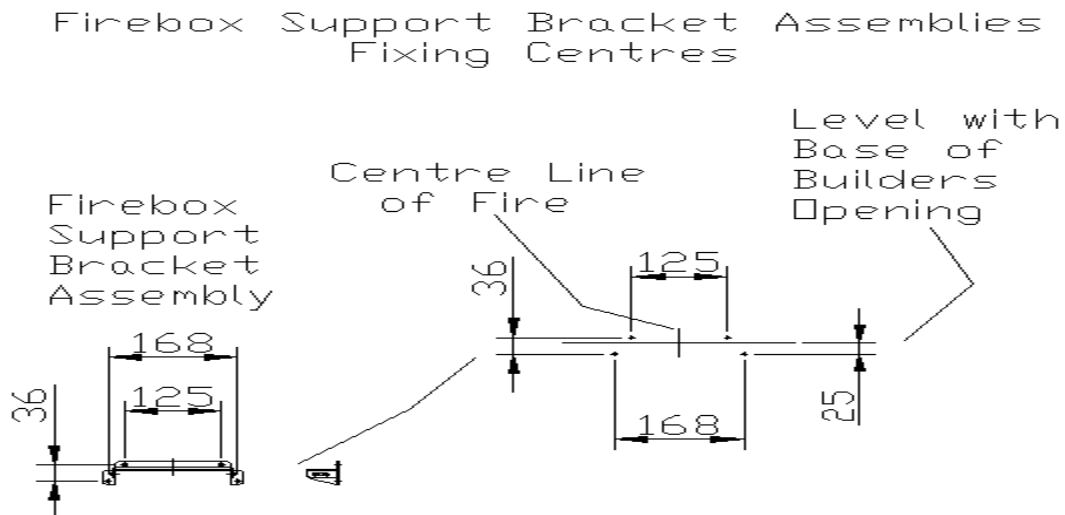

17.5 - FITTING THE FIREBOX

! IMPORTANT !

- a. Using a Dust Sheet or equivalent protect the area around the Fire Installation.
- b. Remove the Firebox and Parts from the box and identify all the parts to the check list on Page 3.
- d. Check that the Gas Supply pipe is in the correct position in the Building Enclosure as detailed in Section 11.
- c. Lay the Firebox on its front face and apply the high temperature sealing foam around the flanges as shown.
- d. Decide if the Firebox is going to be fixed with screws through the flanges or if the Cable Fixing System is to be used.
For Cable Fixing See 16.6 before proceeding to 'i'.
- e. Slide the Firebox into the Enclosure and screw through the holes in the flanges.
- f. The flue system and height should have already been determined so a Flue Canopy should have been supplied to allow connection to a 5" Twin Walled Flue System with a suitable Draught Hood Connector.
- g. Using 15off No8 by 100m screws supplied fix the Flue Canopy into the top of the firebox as detailed below, also see photograph.
 - . With the outlet to the rear locate the rear flange above and resting on the small bracket at the back (provided as a support to help installation) then fix the first screw at the front left centre followed by all the rear screws then add all the remaining screws.
 - . At the front you will see there are only 4 screw positions used.
- h. Now working from outside the Structure make the flue connection to the Flue Canopy.
- i. Now the False Chimney Breast can be fully enclosed with plaster board but before plastering check the next stages.
The plaster should be finished to the face of the 45mm Non Combustible Strips around the fire.

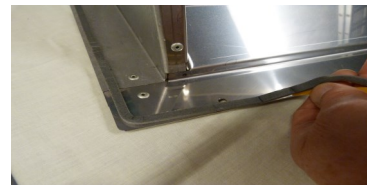

! VERY IMPORTANT !

Before Plastering the False Chimney Breast you must now protect the Firebox.

The inner Painted Surfaces of the Firebox are painted with special paints that could be marked, or damaged during the plastering which is not recoverable. So it is vital that the Opening of the Firebox and edges are masked off before any further building work is started.

The Firebox Cardboard Infill piece can be cut down in height to 314mm and held with tape to protect the Firebox paintwork

Nu-Flame accepts no responsibility for damage caused to the painted surfaces of the Firebox and to replace the Firebox will mean all the Plastering Work will have to be dismantled.

! VERY IMPORTANT ! The Outer Plaster face must now be allowed to fully dry before proceeding to Fixing the Fire.

NOW PROCEED TO SECTION 20:2 g FOR FITTING THE FIRE

17.6 - CABLE FIXING SYSTEM

Reference should be made to the diagram below.

The cable fixing system will also pull the unit tight back into the Building Enclosure to make a good seal. This is very important to ensure efficient and safe operation of the fire.

See Diagrams Below

The Cable fixing kit consists of , 2 cables, 4 Eye Bolts, 2 Cable Fixing Adjusters, Nuts and Lock Screw and 4 Rawlplugs.

Important : Special High Temperature Rawlplugs have been supplied and must be used.

Details of the Cable Fixing System are as follows:

- i. Working in side the Building Enclosure and with reference to the diagrams, at 5mm below the base of the Building Enclosure drill the 2 lower holes at 520mm centres using a 10mm drill. Dependant on the Enclosure Depth it may be necessary to sink-in the Eye Bolts so before fixing the Rawlplugs chamfer the outer part of the hole.
- ii. Now drill 2 upper holes also at 520mm centres at 265mm above the holes just drilled. Dependant on the Enclosure Depth it may be necessary to sink-in the Eye Bolts so before fixing the Rawlplugs chamfer the outer part of the hole.
- iii. Insert the Rawlplugs and secure the Eye Bolts.

Very Important : Ensure the Eye Bolts are secure as this will affect the flue sealing of the fire which could create an unsafe situation.

- iv. With the 4 Eye Bolts secure and in position you will see two tabs at the top corners of the Firebox. Feed the cables through the tabs. Position the Firebox close to the Enclosure Opening and then feed the 2 cables through the top eye bolt then lower eye bolt in turn. Now slide the Firebox into the Enclosure Opening.
- v. Collect the 2 Cable Fixing Brackets and locate them into the fixing slots in the base of the Firebox on each side as shown and secure with the screw provided.
- vi. Through the opening in the base of the Firebox locate the 2 Cables and each in turn feed through the hole in the Cable Fixing Bracket just fitted. Now collect the 2 Cable Fixing Adjusters and Locking Screws and feed the cable through the Adjuster and Locking Screw. Push the Firebox up against the Enclosure Opening whilst applying tension to the Cable then tighten the Locking Screw onto the Cable. Now tension up the Cable Fixing Adjuster to seal the Firebox to the opening. If any gaps are seen around the Flange of the Firebox they must be sealed with fire cement or high temperature sealant.

CABLE FIXING CENTRES

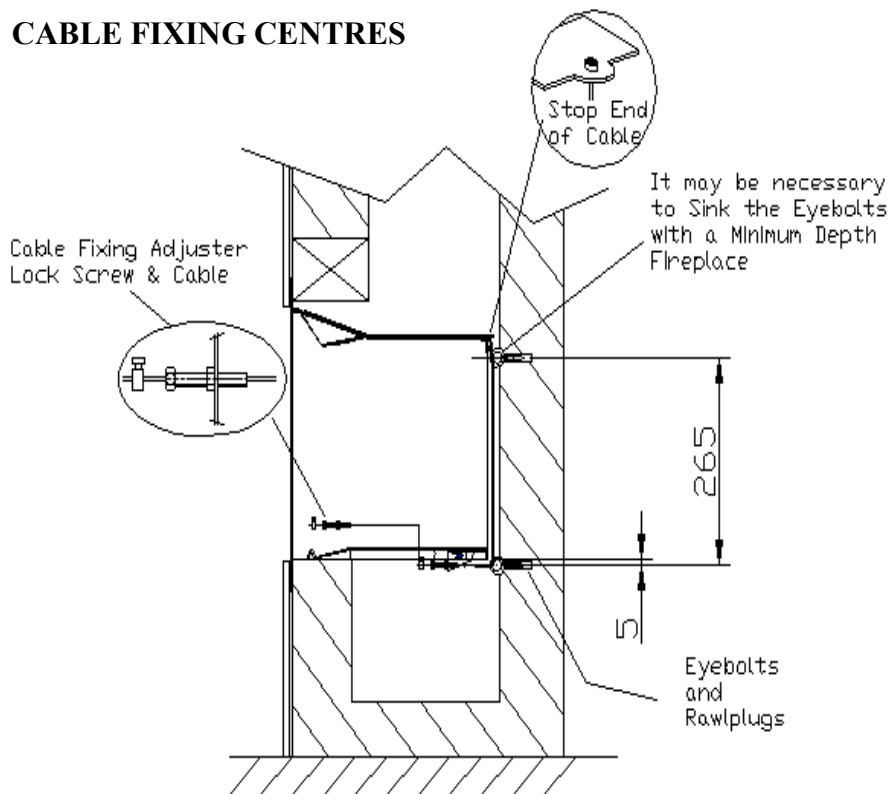

Cable Fixing Bracket

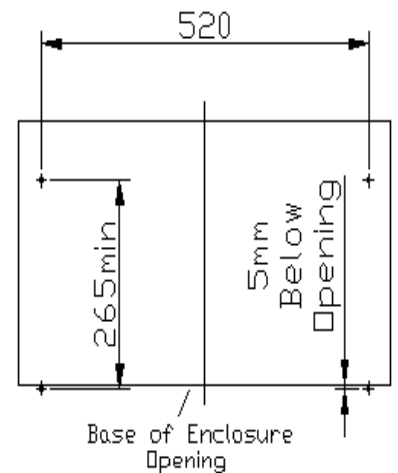
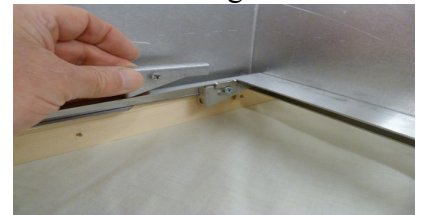

Now Go Back To Section 20:6 i For The Next Installation Stage.

18. - INSTALLATION FOR TRIMLESS FIRES INTO FALSE CHIMNEY BREAST WITH A TWIN WALLED 125mm (5") FLUE & BUILDING ENCLOSURE REQUIREMENTS ENCLOSURE BUILDING & FIRE SURROUND REREQUIREMENTS
Two Optional Edge Kits Are Available See Below For Which Best Suits Your Application
If a Wall Mounted Television is being Considered Also Make Reference to Section 18

This Section Covers Installations Into False Chimney Breasts and their Construction, however you may also be either opting for a Trimless Wall Mounted Installation or creating the Trimless effect using a Fire Surround Back Panel requiring the appropriate Edging Kit.

It is important that you read the whole Section before proceeding with any Building Work.

18.1 - WALL COVERINGS

All Wall Coverings or Combustible Cladding Must be removed from the wall where the False Chimney Breast will be sited. With any form of heating appliance convection air will rise up past the fire carrying particles of dust that will in time result in varying degrees of wall staining. The fire provides an high heat output so we recommend that any wall coverings are best cut back to within 10mm of the flanges of the fire to reduce the transmitting of temperature through the flanges of the fire.

The Trim will then cover both the Fires flanges and the cut back area of the wall covering.

Over time some staining might occur and we therefore suggest due consideration is taken when considering the use of patterned paper around the fire.

Due to the heat output of The Icona 600+ it is not recommended to use blown vinyl wall covering around the fire.

18.2 - CLEARANCES TO SHELVES & COMBUSTIBLE MATERIALS

- a. A 150mm non combustible or combustible shelf can be fitted above the fire but must be positioned at least 150mm above the builders opening for Harmony, Deluxe and Concept Trim Styles (see Section 8) and at least 180mm for Grande Style Trim. For deeper shelves they must be raised a further 25mm for every extra 25mm of depth.
- b. Any combustible sidewall must be at least 275mm from the inside of the Builders/Fireplace Opening.
- c. With all heating appliances, soft furnishings, decorations and wall coverings may discolour or scorch if placed too close.
- d. No combustible material, e.g. curtains must be closer than 500mm to the Builders Opening.

Note : If a shelf is placed to close to the trim or opening it may have an adverse effect on the Trim Finish.

18.3 - FALSE CHIMNEY BREAST ENCLOSURE CONSTRUCTION

REFERENCE SHOULD BE MADE TO THE DIAGRAMS

FALSE CHIMNEY BREAST ENCLOSURE

Very Important : The False Chimney Breast Studding Structure should be constructed to surround the Enclosure Opening but the plaster board Must be left off to allow for connection of the Flue System.

- a. All Wall Coverings or Combustible Cladding Must be removed from the wall where the False Chimney Breast will be sited.
- b. It is recommended that a qualified person constructs the building enclosure.
- c. The Building Enclosure should be constructed with Studding and Must be lined with 12mm thick Non Combustible board, e.g. Superlux Board or equivalent as shown in the diagram and as detailed below:
 - . The 12mm thick Non Combustible lining must extend to a height of 500mm from the Base of the Opening at back and front.
 - . The 12mm thick Non Combustible lining must extend down below the base of the opening at the back by 100mm.
 - . The Supporting Base at the front Must be lined with 12mm thick Non Combustible Board both on top where the fire will sit and on the inner face.
 - . The Sides of the Enclosure Must also be lined with 12mm thick Non Combustible material.

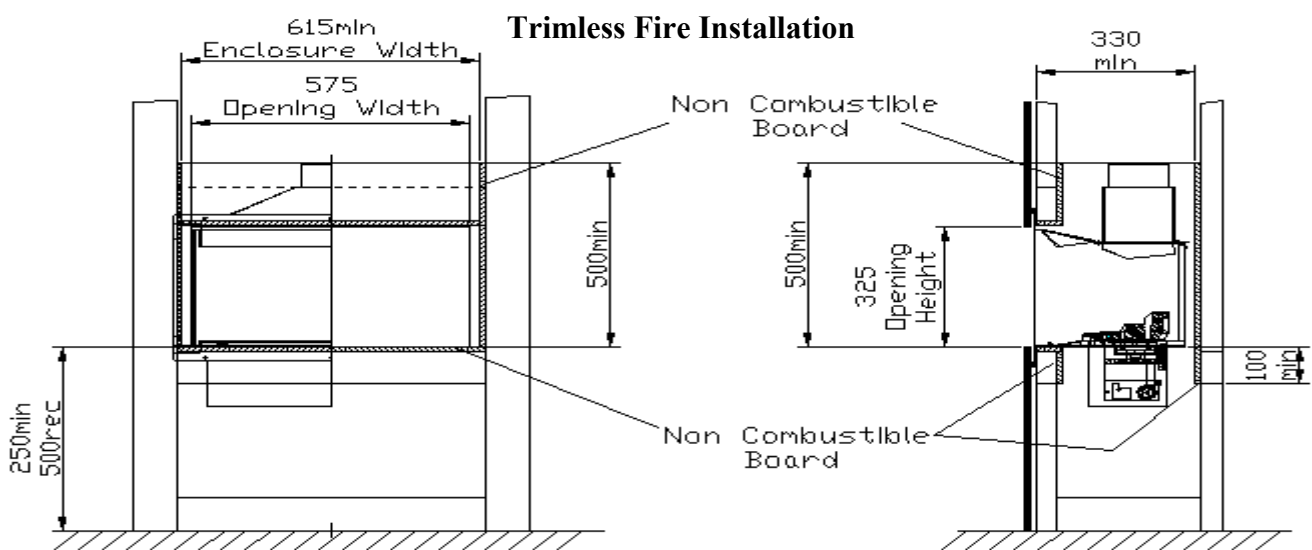

- d. The diagram show the sizes of the Building Enclosure and Enclosure Opening.
- e. No Combustible materials must be present in the Enclosure.
- f. First determine the preferred bottom position of the Enclosure Opening, we recommend 500mm but the minimum is 250mm, however for the minimum height the Enclosure base, sides, back and front must be fully lined down to the base.
- g. Any Fire Surround design should take account of the preferred height position of the Fire and this will affect the position of the Enclosure Base, also see 'I'.

- h. If a Wall Mounted Television is being considered then you should also consult Section 18 as this could determine the preferred Height position of the Fire and Enclosure Opening.
- i. The Inner Base of the Builders Enclosure must be at least 180mm below the base of the cut out to cater for the sunken Burner System.
- j. The Builders Opening must be level and between 575mm wide and 325mm as shown.
- k. There are no limitations on the depth of Fire Surrounds Shelf/Mantel, for Non Combustible Shelf/Mantels however where they are deeper than 150mm and below the minimum position of 150mm above the Enclosure opening they will reduce the Radiant Heat. It is therefore recommended that Natural Materials are used as some Micro Marbles claiming 150 Centigrade Ratings as they can suffer from odour, blistering and discolouration.
- l. Provided the bottom of the Enclosure Opening is at least 250mm above the floor there is no depth requirements for a Fire Surround base/hearth.
- m. Where the Installation is not to use a Fire Surround then the minimum height to the bottom of the Enclosure Must be 250mm minimum and it is recommended that a tactile barrier of 150mm deep is provided.
- n. For Fire Surround applications the height above the floor to the Enclosure Opening can be reduced below the minimum of 250mm however the depth of the Fire Surround base/hearth **must** be at a minimum of 150mm depth.

There are now two Options:

Option 1: For Trimless Installations using a Fire Surround Back Panel consult items ' p to s'.

Option 2: For Trimless Installations not using a Fire Surround consult items ' t to x'.

Option 1

- o. If a Fire Surround is being considered it may have to be Purpose Made and designed see ' l ' .
- p. Slate or Marble Fire Surrounds or Slips and/or any adhesives used must have a 150 Degree Centigrade rating. Care should be taken with Micro Marbles claiming to have a 150Centigrade Rating as they can suffer from odour, blistering and discolouration. A Fire Surround consisting of both Combustible and Non Combustible materials can be used, however the following applies:
 - . The Lower Shelf or Hearth below the fire Must always be Non-Combustible.
 - . The Upper Shelf or Mantel above the fire can be either Combustible or Non Combustible, however for Combustible it Must be positioned 150mm above the Enclosure Opening for shelves up to 150mm deep and raised 25mm for every 25mm of extra depth.
 - . Any side members of the Fire Surround can be either Combustible or Non Combustible, however for Combustible they Must be at least 100mm from the Enclosure Opening for depths of up to 100mm deep and moved a further 25mm for every 25mm of extra depth.
 - . If Non Combustible the Upper Shelf-Top , Sides and Hearth-Base of the Fire Surround can be within 15mm of the Enclosure Opening.
- q. We recommend that the False Chimney Breast is ventilated at both top and bottom to keep the structure cool.
- r. If the Fire Surround back panel is to be used to provide the correct sized front opening (see ' j ') then the Enclosure and False Chimney Breast will have to be finished and plastered, however this **must not** be done until you have made the flue connection and referred to Section 11 Gas Supply before proceeding to **18.4**.

Option 2

- s. If the installation is **Not** to use a Fire Surround Back Panel to create the Trimless appearance then the Firebox will be fixed directly to the Building Enclosure before the Plaster Board is applied. It is **Very Important** that the Building Enclosure has been made such that when the Firebox is fitted it seals off the Enclosure and therefore prevents any temperature escaping into the False Chimney Breast.

Note: The Flanges, Seal and Fixing will stand off from the Enclosure by 6 to 7mm affecting the position of the Plaster Board therefore the Studding of the False Chimney Breast should cater for this.

- t. **Important:** No Plaster Board **must** be applied until the Firebox, Flue Canopy and Flue Connection has been made.
- u. The Flue Manufacturers Installation Instructions Must also be followed for this Installation.
- v. The Building Enclosure should have provision for a gas supply as detailed in Section 11 during construction of the Enclosure.
- w. We recommend that the False Chimney Breast is ventilated at both top and bottom to keep the structure cool. The Chimney Breast will now have to be finished and plastered, however this **must not** be done until you have made the flue Connection and referred to Section 11 Gas Supply before proceeding to **18.4**.

IMPORTANT : The following stages must now be carried out before the False Chimney Breast is Plaster Boarded.

18.4 - FIXING THE FIREBOX SUPPORT BRACKET ASSEMBLY

We Recommend the use of the Firebox Support Bracket as it is provided to cater for the weight of the Fire when fully Installed with the Burner Box Assembly and Flue Hood or the Flue Canopy dependant on the type of Installation.

- a. One Support Bracket Assembly is provided with the fire for fixing at the rear of the Builders Enclosure. The Support Bracket provides adjustment for Building Enclosure depths up to 345mm deep. For deeper Building Enclosures spacers will be required but they must be made of a non- combustible material..
- b. The top of the Support Brackets should be fixed to the rear of the Builders Opening such that they are level with the base of the Enclosure Opening.
- c. The fixing should be positioned as shown in the diagram on the next page starting with the lower holes 25mm below the level of the bottom of the Enclosure Opening and the remaining holes as shown.

See diagram on next page.

Firebox Support Bracket Assemblies Fixing Centres

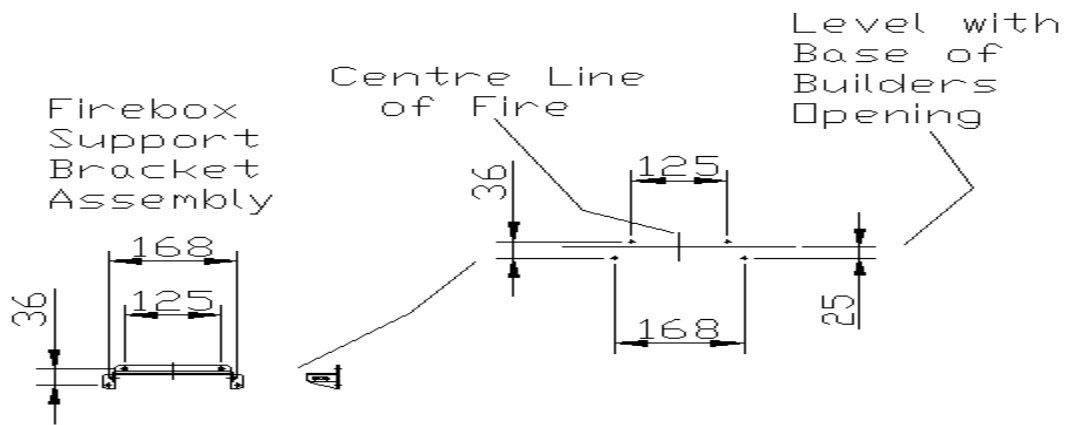

18.5 - FITTING THE FIREBOX

! IMPORTANT !

IMPORTANT : The following stages must now be carried out before the False Chimney Breast is Plaster Boarded.

- a. Using a Dust Sheet or equivalent protect the area around the Fire Installation.
- b. Remove the Firebox and Parts from the box and identify all the parts to the check list on Page 3.

Important : Now proceed and only remove the parts in the following sequence:

- i) Remove the Fuel Tray Assembly surrounding the Burner.
 - ii) Now working at the left and using the black plastic lever lift upward the Battery Box, disconnect the Battery Lead and set aside.
 - iii) Again working at the left side lift up the Battery Cassette Assembly by pulling upward on the tabs inside and set aside.
 - iv) Now to the right lift upward and remove the large Burner Box Assembly (complete with Burner Tray Assembly).
- c. Check that the Gas Supply pipe is in the correct position in the Building Enclosure as detailed in Section 11.
 - d. Lay the Firebox on its front face and apply the high temperature sealing foam around the flanges as shown above.
 - e. Decide if the Firebox is going to be fixed with screws through the flanges or if the Cable Fixing System is to be used. For Cable Fixing See 17.6 before proceeding to 'i'.
- The Optional Edge Kit four part frame should now be made ready for fixing through the Firebox flanges.**
Reference to be made to the Instructions supplied with the Edge Kit.
- f. Slide the Firebox into the Enclosure and screw through the holes in the flanges (with edge kit) to the studded frame around the opening. If the edge kit is not being used then you can fix the Firebox with the Cable Fixing System (if preferred) see 18.6.
 - g. The flue system and height should have already been determined so a Flue Canopy should have been supplied to allow connection to a 5" Twin Walled Flue System.
 - h. Using 10off No6 by 10mm screws supplied fix the Flue Canopy into the top of the firebox as detailed below, also see photograph.
 - . With the outlet to the rear locate the rear flange above and resting on the small bracket at the back (provided as a support to help installation) then fix the first screw at the front left centre followed by all the rear screws then add all the remaining screws.
 - . At the front you will see there are only 4 screw positions used.
 - i. Now working from outside the Structure make the flue connection to the Flue Canopy.
 - j. Now the False Chimney Breast can be fully enclosed with plaster board but before plastering check the next stages.
 - k. Ensure that any gap between the back of the plaster board and the fire is sealed off with a suitable sealant, in keeping with the decoration colour .e.g. white.

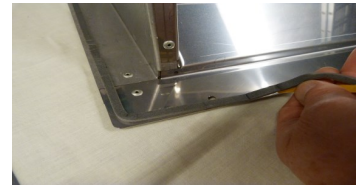

! VERY IMPORTANT !

Before Plastering the False Chimney Breast you must now protect the Firebox.

If you have used the Optional Edge Kit then protect the inner faces with masking tape or equivalent before plastering.

The Edge Kit is provided to cover the inner edge of the plaster board and provide a leading edge for plastering up to.

The inner Painted Surfaces of the Firebox are painted with special paints that could be marked, or damaged during the plastering which is not recoverable. So it is vital that the Opening of the Firebox and edges (also Edge Kit) are all masked off before any further building work is started.

The Firebox Cardboard Infill piece can be cut down in height to 314mm and held with tape to protect the Firebox paintwork.

- . If the Optional Edge Kit has not been used then there will be a gap between the back of the Fire Surround Back panel and the fire. The gap **must** be sealed off around the cut out with a suitable high temperature sealant. We do not recommend the use a foam sealant for this application as this will flow up the gap sealing off the insulating air gap between the inner wall and the Fire Surround Back panel causing it to run hot when the fire is in operation.

Nu-Flame accepts no responsibility for damage caused to the painted surfaces of the Firebox and to replace the Firebox will mean all the Plastering Work will have to be dismantled.

! VERY IMPORTANT ! The Outer Plaster face must now be allowed to fully dry before proceeding to Fixing the Fire.

NOW PROCEED TO SECTION 20:2 i FOR FITTING THE FIRE

18.6 - CABLE FIXING SYSTEM

Reference should be made to the diagram below.

The cable fixing system will also pull the unit tight back into the Building Enclosure to make a good seal. This is very important to ensure efficient and safe operation of the fire.

See Diagrams Below

The Cable fixing kit consists of , 2 cables, 4 Eye Bolts, 2 Cable Fixing Adjusters, Nuts and Lock Screw and 4 Rawlplugs.

Important : Special High Temperature Rawlplugs have been supplied and must be used.

Details of the Cable Fixing System are as follows:

- i. Working in side the Building Enclosure and with reference to the diagrams, at 5mm below the base of the Building Enclosure drill the 2 lower holes at 520mm centres using a 10mm drill. Dependant on the Enclosure Depth it may be necessary to sink-in the Eye Bolts so before fixing the Rawlplugs chamfer the outer part of the hole.
- ii. Now drill 2 upper holes also at 520mm centres at 265mm above the holes just drilled. Dependant on the Enclosure Depth it may be necessary to sink-in the Eye Bolts so before fixing the Rawlplugs chamfer the outer part of the hole.
- iii. Insert the Rawlplugs and secure the Eye Bolts.

Very Important : Ensure the Eye Bolts are secure as this will affect the flue sealing of the fire which could create an unsafe situation.

- iv. With the 4 Eye Bolts secure and in position you will see two tabs at the top corners of the Firebox. Feed the cables through the tabs. Position the Firebox close to the Enclosure Opening and then feed the 2 cables through the top eye bolt then lower eye bolt in turn. Now slide the Firebox into the Enclosure Opening.
- v. Collect the 2 Cable Fixing Brackets and locate them into the fixing slots in the base of the Firebox on each side as shown and secure with the screw provided.
- vi. Through the opening in the base of the Firebox locate the 2 Cables and each in turn feed through the hole in the Cable Fixing Bracket just fitted. Now collect the 2 Cable Fixing Adjusters and Locking Screws and feed the cable through the Adjuster and Locking Screw. Push the Firebox up against the Enclosure Opening whilst applying tension to the Cable then tighten the Locking Screw onto the Cable. Now tension up the Cable Fixing Adjuster to seal the Firebox to the opening. If any gaps are seen around the Flange of the Firebox they must be sealed with fire cement or high temperature sealant.

CABLE FIXING CENTRES

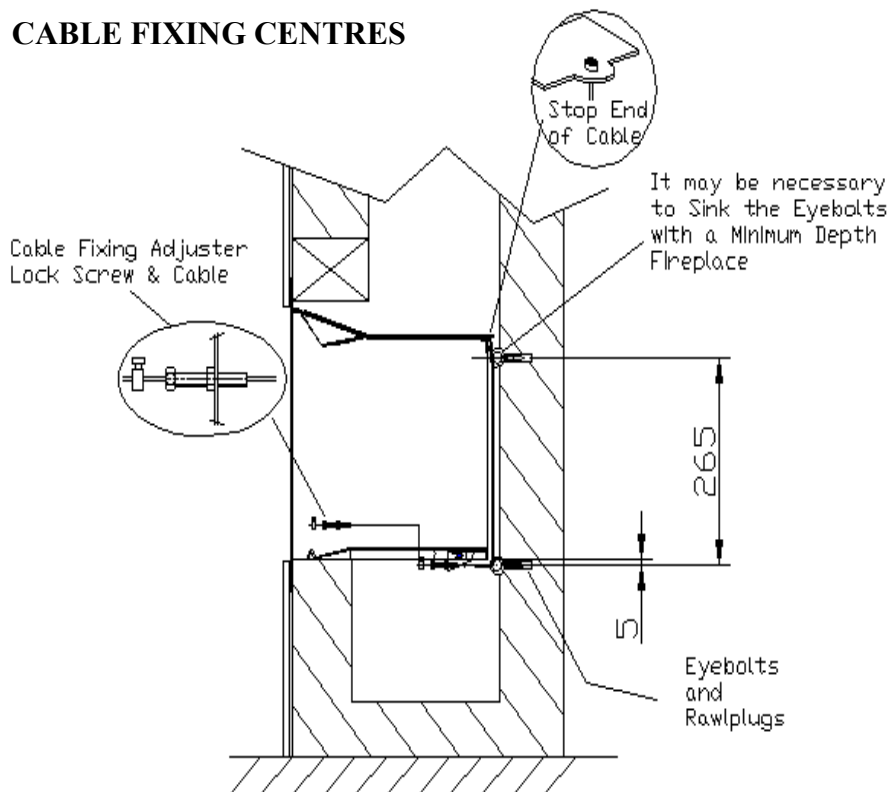

Cable Fixing Bracket

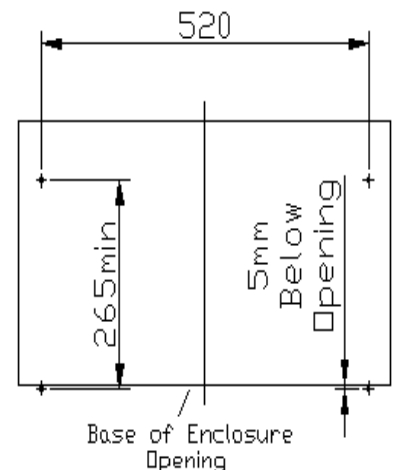
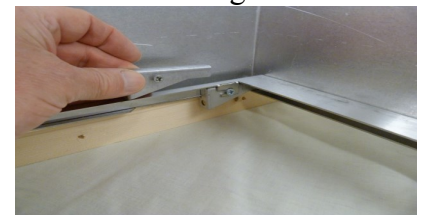

Now Go Back To Section 18:7 h For The Next Installation Stage.

19. - INSTALLATION INSTRUCTIONS FOR WALL MOUNTED TELEVISIONS ADDITIONAL REQUIREMENTS

These Instructions detail the Installation Requirements for Wall Mounted Televisions when Installed above the Fire and should be considered with all other Installation Requirements of the Fire.

IMPORTANT: Due to the High Heat Output of the Fire The Installation Requirements of these Instructions **MUST** be Adhered To For Wall Mounted Televisions.

IMPORTANT: The Fire will affect the height and position of the Television therefore it is important to check what height position options are possible.

19.1 - GENERAL

Before continuing with the Television Installation it is important to determine if there is the likelihood of the Chimney Breast becoming hot when the Icona is in operation. Some of these checks will only provide assistance if a fire has been previously installed. The following checks will assist but are not conclusive.

- a. Typically Class 1 flues with Dry Lined Walls will normally have acceptable Wall Temperatures.
- b. If a gas fire was installed and the chimney breast shows any signs of over heating e.g. discoloured wall paper, then do not consider Installing a Wall Mounted Television as the Temperatures are likely to be too high.
- c. If a gas fire was installed and the Chimney Breast is finished in Wall Paper and shows no signs of temperature damage then the Wall Temperatures are likely to be acceptable so the Installation can proceed.
- d. A Wall Mounted Television Must Not be sunk into the wall as it will not be in an acceptable ventilated position and this is only acceptable if additional fan cooling ventilation is provided. It is also likely that higher temperatures from the flue within the Chimney Breast will occur.
- e. The Wall Mounted Television must be mounted on a suitable bracket or angled bracket that meets the Television Manufactures requirements and spaces the Television at least 35mm away from the Chimney Breast.
- f. After reading the Installation Requirements you should compare this with the preferred height position of the Television.

19.2 - TELEVISION INSTALLATION REQUIREMENTS FOR FIRES WITH TRIMS

Providing the Chimney Breast temperatures have been confirmed as detailed in the General Section, testing of the Icona 600+ has shown that the actual Ambient Temperature of 90° Fahrenheit (32° Centigrade) can be achieved and should be suitable for the Installation of a Wall Mounted Television and the Installation Requirements are as follows.

- a. You **Must** take account of the Television Manufacturer's Installation requirements provided within their Instructions.
- b. Where No Shelf is present the bottom edge of the Television must be mounted at least 200mm above the top of the Enclosure Opening see diagram.
- c. For the Fire fitted with either a Combustible Shelf/Fire Surround Mantels or Non Combustible Shelf/Fire Surround Mantels the bottom edge of the Television must be at least 75mm above the shelf, see diagram.
- d. The Television can be Mounted Vertically if desired with a suitable Wall Bracket that spaces the back of the television at least 35mm from the Chimney Breast Wall.
- e. To help provide the preferred viewing position a 15° Angled Wall Mounting Bracket can be used for the Television Installation. A wall bracket with a larger angle **Must Not** be used.
- f. It is recommended that, for aesthetic reasons, due consideration is given prior to Installation for the provision of mains electric, aerial, sound and any other Connections that may wish to be hidden behind the Television. A Qualified Electrician/Specialist should be consulted.
- g. Check First for the positions of any wires within the wall before drilling for the fixings.
- h. Ensure the wall is sound and the wall fixings are secure and able to take the weight of the Television.
- i. Before proceeding with the Installation confirm the preferred Height Position of the Television with the Customer.

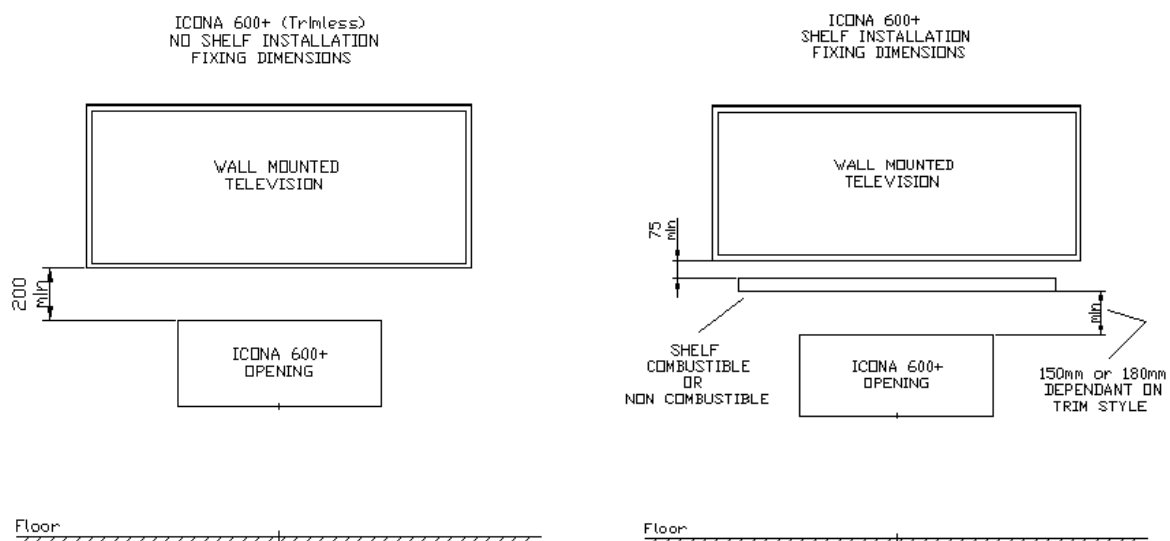

19.3 - TELEVISION INSTALLATION REQUIREMENTS FOR TRIMLESS FIRES

Providing the Chimney Breast temperatures have been confirmed as detailed in the General Section, testing of the Icona 600+ has shown that the actual Ambient Temperature of 90° Fahrenheit (32° Centigrade) can be achieved and should be suitable for the Installation of a Wall Mounted Television and the Installation Requirements are as follows.

- a. You **Must** take account of the Television Manufacturer's Installation requirements provided within their Instructions.
- b. Where No Shelf is present the bottom edge of the Television must be mounted at least 200mm above the top of the Enclosure Opening see relevant diagram.
- c. For the Fire fitted with either a Combustible Shelf/Fire Surround Mantels or Non Combustible Shelf/Fire Surround Mantels the bottom edge of the Television must be at least 75mm above the shelf, see diagram.
- d. For the Fire fitted above a Non-Combustible Shelf/Fire Surround Mantel that is positioned 15mm above the Enclosure Opening bottom edge of the Television must be at least 200mm above the shelf, see diagram.
- e. The Television can be Mounted Vertically if desired with a suitable Wall Bracket that spaces the back of the television at least 35mm from the Chimney Breast Wall.
- f. To help provide the preferred viewing position a 15° Angled Wall Mounting Bracket can be used for the Television Installation. A wall bracket with a larger angle **Must Not** be used.
- g. It is recommended that, for aesthetic reasons, due consideration is given prior to Installation for the provision of mains electric, aerial, sound and any other Connections that may wish to be hidden behind the Television. A Qualified Electrician/Specialist should be consulted.
- h. Check First for the positions of any wires within the wall before drilling for the fixings.
- i. Ensure the wall is sound and the wall fixings are secure and able to take the weight of the Television.
- j. Before proceeding with the Installation confirm the preferred Height Position of the Television with the Customer.

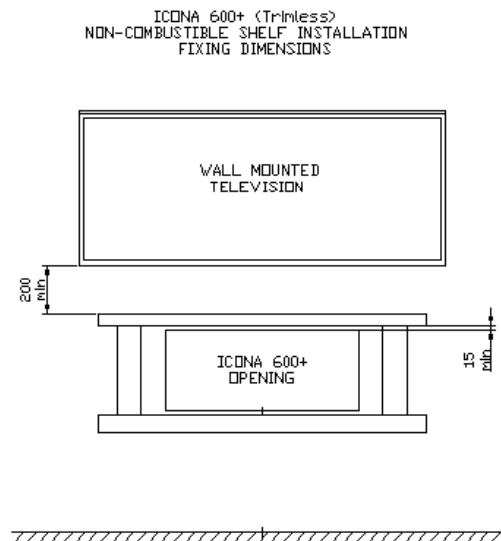
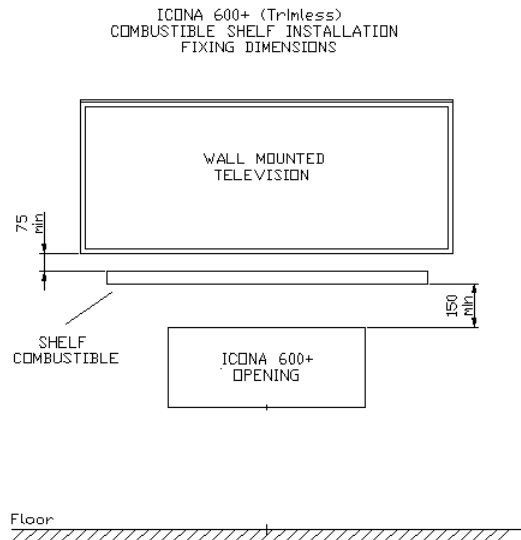
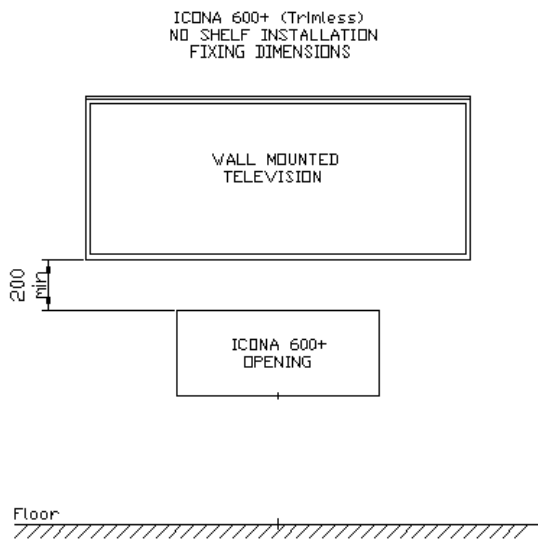

20. - FITTING THE FIRE

20.1 - FOR TRIMLESS FIRES START AT STAGE ' I '

! IMPORTANT NOTE ! TAKE GREAT CARE WHEN WORKING INSIDE THE FIRE NOT TO MARK THE CERAMIC LINING PANELS.

- Using a Dust Sheet or equivalent protect the area around the Fire Installation.
 - Ensure the Building Enclosure is correctly sized and all building work is sound and dry.
 - Remove the Firebox and Parts from the box and identify all the parts to the check list on Page 3.
- Important :** Now proceed and only remove the parts in the following sequence:
- Remove the Fuel Tray Assembly surrounding the Burner.
 - Now working at the left and using the black plastic lever lift upward the Battery Box, disconnect the Battery Lead and set aside.
 - Again working at the left side lift up the Battery Cassette Assembly by pulling upward on the tabs inside and set aside.
 - Now to the right lift upward and remove the large Burner Box Assembly (complete with Burner Tray Assembly).
- Check that the Gas Supply pipe is in the correct position in the Building Enclosure as detailed in Section 11.
 - Lay the Firebox on its front face and apply the high temperature sealing foam around the flanges as shown above.
 - The Firebox can be fixed with screws through the flanges, however we recommend the Cable Fixing System is to be used.
See Cable Fixing Below or proceed to ' h ' for screw fixing through the flanges.

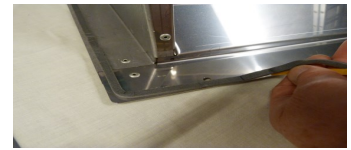

CABLE FIXING SYSTEM

- The cable fixing system will also pull the unit tight back into the Building Enclosure to make a good seal. This is very important to ensure efficient and safe operation of the fire. See Diagrams Below
The Cable fixing kit consists of , 2 cables, 4 Eye Bolts, 2 Cable Fixing Adjusters, Nuts and Lock Screw and 4 Rawlplugs.
Important : Special High Temperature Rawlplugs have been supplied and must be used.
Details of the Cable Fixing System are as follows:
 - Working in side the Building Enclosure and with reference to the diagrams, at 5mm below the base of the Building Enclosure drill the 2 lower holes at 520mm centres using a 10mm drill. Dependant on the Enclosure Depth it may be necessary to sink-in the Eye Bolts so before fixing the Rawlplugs chamfer the outer part of the hole.
 - Now drill 2 upper holes also at 520mm centres at 265mm above the holes just drilled. Dependant on the Enclosure Depth it may be necessary to sink-in the Eye Bolts so before fixing the Rawlplugs chamfer the outer part of the hole.
 - Insert the Rawlplugs and secure the Eye Bolts.
- Very Important :** Ensure the Eye Bolts are secure as this will affect the flue sealing of the fire which could create an unsafe situation.
- With the 4 Eye Bolts secure and in position you will see two tabs at the top corners of the Firebox. Feed the cables through the tabs. Position the Firebox close to the Enclosure Opening and then feed the 2 cables through the top eye bolt then lower eye bolt in turn. Now slide the Firebox into the Enclosure Opening.
 - Collect the 2 Cable Fixing Brackets and locate them into the fixing slots in the base of the Firebox on each side as shown and secure with the screw provided.
 - Through the opening in the base of the Firebox locate the 2 Cables and each in turn feed through the hole in the Cable Fixing Bracket just fitted. Now collect the 2 Cable Fixing Adjusters and Locking Screws and feed the cable through the Adjuster and Locking Screw. Push the Firebox up against the Enclosure Opening whilst applying tension to the Cable then tighten the Locking Screw onto the Cable. Now tension up the Cable Fixing Adjuster to seal the Firebox to the opening.
If any gaps are seen around the Flange of the Firebox they must be sealed up with fire cement or high temperature sealant.

CABLE FIXING CENTRES

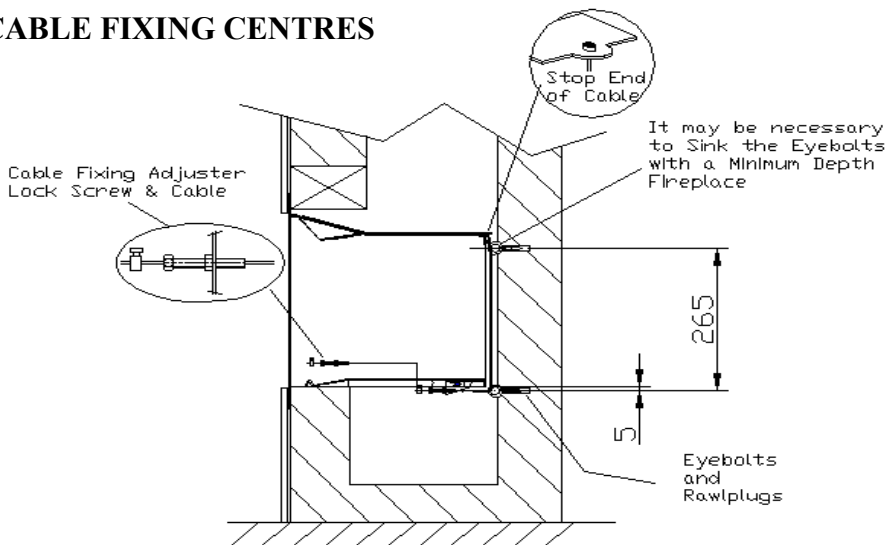

Cable Fixing Bracket

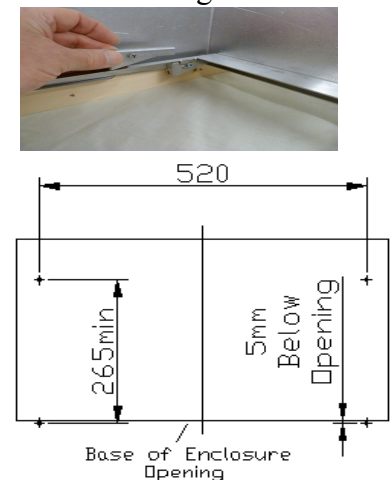

- Slide the Firebox into the Building Enclosure and fix with the holes in the front flanges which can be used if there is sufficient strong material for fixing.

THE FOLLOWING POINTS APPLY TO BOTH FIRES WITH TRIMS & TRIMLESS FIRES

- i. The flue system and height should have already been determined so either the standard Flue Hood will have been supplied or if the flue is lined a Flue Canopy will have been supplied - the fixing process is the same.
However for Standard Flues using the Flue Hood if the flue as an effective height greater than 3meters and as a good draw the Restrictor should now be fitted.



Note : The Restrictor should not be fitted to Lined Flues or those using the Flue Canopy.
Note : For Fitting the Flue Canopy go to stage ' k '.

- . Collect the Restrictor and using 4 of the No6 by 10mm screws supplied fix the Restrictor to the rear of the Flue Hood as shown.



- j. Collect the Flue Hood ready for installation into the Firebox
- . Using 10off No6 by 10mm screws supplied offer the Flue Hood up through the inside of the Firebox as follows.
 - . With the outlet of the Flue Hood to the rear guide it up through the outlet of the Firebox.
 - . Now rest the rear flange above/on on the small bracket at the back of the Firebox, (provided as a support to help installation) then loosely fix the first screw at the front left centre followed by all the rear screws then add all the remaining screws.
 - . At the front you will see there are only 3 screw positions used as the other positions retain the Baffle Assembly.

k. Additional requirements ONLY for Flexible Flues and the Flue Canopy.

The Flexible Flue Connection should be terminated at roof level after the following stages.



- i. Collect the Flue Canopy and pull the Flexible Flue into the Firebox.
- ii. Collect the Flue Canopy and (Important) with the slots and cut away flange at the rear connect and secure the flexible flue.
- iii. Using 10off No6 by 10mm screws supplied offer the Flue Canopy up through the inside of the Firebox as follows.
- iv. Locate the rear flange (with cut away) and guide the Flue Canopy up through the outlet of the Firebox.
- v. Now rest the rear flange above/on the small bracket at the back of the Firebox, (provided as a support to help installation) then loosely fix the first screw at the front left centre followed by all the rear screws then add all the remaining screws.
- vi. At the front you will see there are only 4 screw positions used as the other positions retain the Baffle Assembly.
- vii. Now make the Flexible Flue connection at roof level.

Now proceed to the next stage below.

l. Collect the Burner Box Assembly and prepare as follows:

- i. Working at the right side unscrew and remove the Cover Plate (1 screw) over the Gas Inlet Isolation Elbow.
- ii. At the same side and using a small screw driver release the switch from its bracket by pressing under the switch lift it upward from the bracket then release by passing the wires through the slot in the bracket to release.
- iii. At the front lift the wires at both left and right of their retaining brackets and lift out the Burner Controls Assembly clear of the Burner Box Assembly.
- iv. Now inside the Burner Box at the bottom right remove the 4 screws retaining the Debris-Gas Inlet Plate.

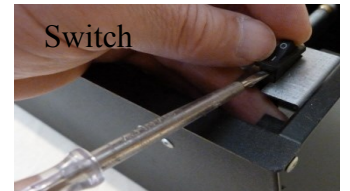

- m. Now install the Burner Box into the cut out on the Left side of the Firebox guiding the Gas Pipe up through the cut out close to the right side of the box, then refit the Debris-Gas Inlet Plate checking the gas pipe will be positioned high enough, 25mm from the top.

n. Reinstall the Burner Assembly in reverse order to ' l ' with the pilot to the back and carry out the following

- i. Position the wires behind the brackets in the front.
- Important :** After refitting the switch ensure the ' I ' is depressed otherwise the fire will not light.
- ii. Now collect the Battery Cassette Assembly and slide it into the space to the left side on the Burner Box ensuring the foam strip seals up against the side of the Burner Box.
- iii. Now collect the Battery Box and install the 4AA Batteries supplied and slide into the cut out in the base of the Battery Cassette.
- iv. Connect the Gas Supply and carry a gas soundness test.

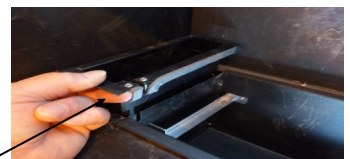

- o. Before proceeding and before fitting the final components it is recommended that the fires ignition and main burner operation are checked as detailed in Section 2. If the fire lights then immediately turn off and proceed. If the pilot does not light and or the main burner does not light then refer to the Service Section 23 for guidance.

- p. Now fit the rear liner and then slide in place the left and right hand side liners.
- q. Finally fit the Baffle Assembly as shown locating the tabs in the slots at the rear and retaining with the 3off No6 by 10mm fixing screws at the front.



! IMPORTANT NOTE ! If when operating the Handset the fire does not operate and a continuous sound is heard then check the Emergency Switch is Depressed at ' I ' and not at the ' O ' setting.

! IMPORTANT NOTE ! Always reseal the pressure test point and check that it is gas tight. (This accounts for a lot of recalls.)

NOW PROCEED TO THE RELEVANT SECTION 21 ARRANGEMENT OF THE FUEL EFFECT

21. - ARRANGEMENT OF THE FUEL EFFECT (WOOD, COALS or PEBBLES Effects as Ordered).

Health & Safety Advice Refractory Ceramic Fibre (RCF)

Advice when working with Fuel Bed Components including Installing, Servicing and Disposal.

The Fuel Effect parts and possible Linings of this fire are made from Refractory Ceramic Fibre (R.C.F.) a Class 2 Carcinogen which is a material designed for this Application. Excessive exposure to these types of materials may cause temporary irritation to eyes, skin and respiratory tract. Therefore take care when handling these articles to ensure dust is kept to a minimum.

It is not necessary to wear protective clothing when handling these articles but we do recommend you follow the normal hygiene rules of not smoking, eating or drinking in the work area, and always wash your hands before eating or drinking.

To minimise the release of RCF fibres during installation and servicing a HEPA filtered vacuum is recommended to remove any dust accumulated in and around the fire both before and after working on it.

When Servicing and if replacing these parts we do not recommend they are broken up but are sealed within a heavy duty polythene Bag and labelled as "RCF waste". This is not classified as "hazardous waste" and may be disposed of at a local licensed landfill site.

Remove all the Fuel Effect Pieces. Set aside all but the 3 Matrix Pieces. Refer to each specific section for Fuel Effect pieces provided. **IMPORTANT:** You may notice small white marks on the Matrix pieces. This is part of the production process. Refer to the Photographs below showing how to fit the Fuel Tray, Battery Grille and 3 Matrix Pieces first.

! TIP ! Take care not to damage or mark liner panels.

- a. Add three quarters of the Gravel or Stones supplied to the Fuel Tray as supplied with the Fuel Effect and then fit the Fuel Tray around the Burner as shown.

Note : The remaining Gravel and Stones will be added later.

Note : Wood Effects Bark Pieces will have been supplied.
Do Not add these until all Wood Pieces have been fitted.



- b. Fit the Left Matrix Piece as shown.
Ensure it sits inside the Burner Tray and up against the metal tabs at the back and Fuel Tray at the Front.
It may help if you move the Matrix from back to back and side to side to ensure it is positioned correctly.
There should be a gap behind the Matrix once fitted.



- c. Fit the Centre Matrix Piece as shown.
Ensure it sits up against the metal tabs at the back and lines up with the left Matrix piece.



- d. Fit the Right Hand Matrix Piece as shown.
Ensure it sits up against the metal tabs at the back and lines up with the other Matrix pieces.
Now centralise the 3 Matrix Pieces over the burner.



Now Proceed to the Relevant page for the Fuel Option supplied, Page 35 Logs, Page 38 Pebbles and Page 42 Coals.

21.1 Arrangement of Wood Effect Pieces

The Wood Effect consists of the following:

10 different logs each are numbered.

A bag of multi coloured gravel.

A bag of Black Bark pieces.

A bag of Grey Bark pieces.

5 Fir Cones.

- a. Fit Wood Piece No1 at the Left rear of the Matrix as shown.



- b. Fit Wood Piece No 2 at the Centre rear of the Matrix as shown. The Wood Piece should overlap the Centre Piece slightly at the front as shown.



- c. Fit Wood Piece No 3 at the Right rear of the Matrix as shown. The Wood Piece should overlap the Centre Piece at the front as shown. Now Adjust the three Wood Pieces to ensure any overhang is even at the sides.



- d. Fit Wood Piece No 4 on the Left Centre area of the Matrix with the branch sitting in the groove in the Rear Wood Piece as shown .



- e. Fit Wood Piece No 5 on the Right Centre area of the Matrix with the branch sitting in the groove in the Rear Wood Piece as shown.



Pilot gap

Important: Now adjust the 2 central Wood Pieces to allow a gap at the centre for viewing the Pilot.

- f. Fit Wood Piece No 6 on the Left Front area of the Matrix with the branch overlapping the Matrix as shown. The Wood piece should butt up against the Wood Piece Behind.



- g. Fit Wood Piece No 7 on the Right Front area of the Matrix up against the Wood Piece just fitted as shown.



- h. Studying the Photograph first, fit Wood Piece No 8 so that at the front it rests in the indent in left front Wood Piece 6 and sits in the indent in Central Wood Piece 4 and its rear Branch rests in the indent in Rear Wood Piece 2. You may need to adjust the Wood Pieces involved slightly to allow the Wood Piece to locate in the indents.



- i. Studying the Photograph first, fit Wood Piece No 9 so that at the front it rests in the indent in right Front Wood Piece 7 and rests in the groove in Wood Piece just fitted and locates in the indent to the right in Rear Wood Piece 2. You may need to adjust the Wood Pieces involved slightly to allow the Wood Piece to locate in the indents.



Note : There is no Wood Piece No10

- j. Studying the Photograph first, fit the final Wood Piece No 11 so that at the front it rests in the indent in front Wood Piece No7, locates up against the upward branch on Wood Piece No 5 and rests in the indent in rear Wood Piece No2. You may need to adjust the Wood Pieces involved slightly to allow the Wood Piece to locate in the indents.



k. Add the remainder of the Gravel , then Bark pieces and Fir Cones to the Fuel Tray also covering the left and right black area of the fuel tray as shown.

Check all Wood Piece positions to the Photograph below and make adjustments where necessary and ensure all the Wood Pieces are located securely.



I. Add Gravel with Bark Pieces and Fir Cones to the Fuel Tray also covering the left and right black area's of the fuel tray as shown. The Bark Pieces can be broken into smaller pieces To help create the desired effect.

Also add Gravel to the front sloped area hiding the black area making sure not to place any gravel in the gap in front of the Fuel Tray. (Optional)

Finally check all Wood Piece are located as shown in the Photograph above and make adjustments where necessary.

The Fuel Bed Arrangement is now complete proceed to Section 22

21.2 - Arrangement of Pebble Effect Pieces

Note : The 3 Matrix Piece and Fuel Tray should already be fitted see Page 34.

The Pebbles Kit consists of the following:

22off Small Pebbles, (Not Marked) in different colours.

16off Pebbles Marked No1 in different colours.

2off Angular shaped Pebbles Marked ' E '.

1off Large Pebble one Marked ' CR '.

1off each of Large Pebbles ONE Marked ' DL ' & one ' DR ' in different colours.

2off Small Triangle Shaped Pebbles, (Not Marked)

A bag of White Gravel.

A bag of White Stones.

**Note: We recommend you alternate the colours as you place the Pebbles.
Leave gaps between the Pebbles when positioned.**

- a. Fit 4off Pebbles marked No1's at the rear of the Matrix about the centre as shown.



- b. Fit 4off Small Pebbles (not marked) at the rear of the Matrix Two either side of the Pebbles just placed.



- c. Fit 2off Pebbles No1's at the rear of the Matrix one either side on top of the Pebbles just placed.



- d. Collect the 2off Pebbles marked DL & DR and working at the centre of the Matrix place DL to the left and DR to the right as shown.
The Pebbles are cut away at the back to allow them to be located around the lugs on the Matrix.

Ensure a gap is left for viewing the Pilot.



- e. Collect the 2off Angular Pebbles marked ' E ' and place one at each end up against the Pebbles last placed.



- f. Collect 2off Pebbles No1's and place one at each end sloping up against the Pebbles previously placed as shown.



- g. Collect 1off Pebble marked CR and place at the centre of the Matrix pointing towards the back on top off the Pebbles previously placed as shown.



- h. Collect 3off Pebbles No1's and place centrally at the back on top of the rear Pebbles as shown.



- i. Collect 1off Pebble No1's and place centrally resting on the front area of the matrix and sloping towards the back as shown.



- j. Collect 6 off Small Pebbles (not marked) and place them as shown two each side on the front of the Matrix and three Centrally placed on the Fuel Tray. It may also be necessary to adjust the gravel in the Fuel Tray to allow the Pebbles to sit flat. Also space the Pebbles as shown.



- k. Take 2 off Pebbles No1's and place as shown either side of the front central Pebble on top of the Small Pebbles just placed. Ensure the Pebbles **Do Not** rest up against the Pebbles behind and the gap for the flame is maintained.



- l. Take 2 off Pebbles No1's and place on each side sitting on top of the Small Pebbles at the front resting length ways as shown.



- m. Take 8 off Small Pebbles (not marked) and working at the Front Left and Right corners place four on each side as shown partly on the on Matrix and the angled part of the Fuel Tray.



- n. Take the 2 off Small Triangle Shaped Pebbles (not marked) and place them at each corner on top of the Small Pebbles just placed as shown.



- o. Take 2 off Small Pebbles (not marked) and again working at the Front Left and Right corners place two above the Small Triangle Pebbles just placed as shown.



- p. Now place the last 2 off Small Pebbles (not marked) as shown.



Now add the remaining Gravel and White Stones provided and place on top of the Gravel in the Fuel Tray area between the Small Pebbles as shown.

- q. You can also add Gravel to the front sloped area hiding the black area making sure not to place any gravel in the gap in front of the Fuel Tray. (Optional).

Check all Pebbles are in line with the Photograph below and make adjustments where necessary.

You **Must Not** place any Stones or Gravel anywhere on the Main Burner or Side Grille areas.

The Fuel Bed Arrangement is now complete proceed to Section 22

21.3 - Arrangement of Coal Effect Pieces

Note : The 3 Matrix Piece and Fuel Tray should already be fitted see Page 34.

The Coal Kit consists of the following:

- 9off Large Coals, (45mm Cube Coals).
- 15off Long Coals, (35mm Square by 50mm Long Coals).
- 17off Mini Coals, (25mm Square by 30mm Long Coals).
- 27off Small Coals, (25mm Cube Coals).
- A Bag of Multi Coloured Gravel.

When placing the coals allow small gaps between coals and ensure no gaps for the Flames are maintained.

- a. Fit 5off Large Coals at the rear of the Matrix in the centre as shown.



- b. Fit a further 4off Large Coals centrally on top of those just placed as shown.



- c. Collect 4off Mini Coals and working at the rear Left and Right corners place two length ways at each side as shown. Adjust the outer coal so it sits slightly forward.



- d. Collect 2off Mini Coals and 2off Small Coals and again working at the rear Left and Right corners place one off Mini and one off Small Coal as shown.



- e. Collect 6off Long Coals and working along the centre of the Matrix place as shown with the outer coals placed at the edge of the matrix and leaving gaps.

Very Important

Ensure a gap is left at the centre to allow the Pilot to be seen.

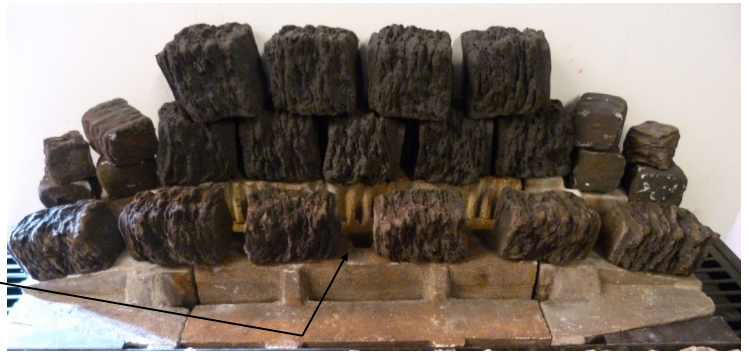

- f. Collect 3off Long Coals and working centrally place the Coals on top of those just placed as shown.

Very Important

Ensure the coals do not rest on the coals behind leaving a gap for the flame.



- g. Collect 4off Mini Coals and place them length ways two each side about the centre as shown.



- h. Collect 4off Small Coals and working at the central Left and Right sides place two Small Coals as shown.



- i. Collect 2off Long Coals and place centrally along the Front of the Matrix as shown.



- j. Collect 4 off Mini Coals and working at the Left and Right front corners add two each side as shown. The Outer Coal should be placed length ways towards the back.



- k. Collect 2 off Long Coals and working at the front add centrally one each side as shown.



Very Important

Ensure the coals do not rest on the coals behind leaving a gap for the flame.

- l. Collect 3 off Mini Coals and place them centrally at the front length ways towards the back as shown.



Very Important

Ensure a gap is left at the centre to allow the Pilot to be seen.

- m. Collect 2 off Small Coals and place them at the Left and Right front corners on top of the existing Coals as shown.



- n. Collect 8 off Small Coals and working at the Left and Right front corners place four each side as shown.



- o. Collect 2 off Small Coals and working at the Left and Right front corners place one each side on top of the coals just placed as shown.



- p. Collect 11 off Small Coals and place them centrally on top of the Gravel in the Fuel Tray as shown. It may be necessary to adjust the Gravel pieces to allow the Coals to sit properly.



Important : Ensure None of the Coals have dislodged and are covering any of the Flame Slots.

You can add the remaining Gravel on the Fuel Tray areas between the Small Coals.
You **Must Not** place any Gravel anywhere on the Main Burner or Side Grille areas.

- q. You can also add Gravel to the front sloped area hiding the black area making sure not to place any gravel in the gap in front of the Fuel Tray. (Optional).

You **Must Not** place any Gravel anywhere on the Main Burner or Side Grille areas.

The Fuel Bed Arrangement is now complete proceed to Section 22

22. - TESTING, COMMISSIONING & USE

- ! IMPORTANT NOTE !** During its first period of use any protective coatings and oils will burn out of the fire and it is wise to ventilate the room for the first hour; also advise the customer that this may persist for the first few days until the fire is fully burnt-in.

22.1 - LIGHTING THE FIRE

- Reference to Section 2 in the Users Instructions 'Lighting & Controlling the Fire' will show how to light and operate the fire.
- Check that the supply pressure to the fire is at the pressures required, 20mbar Natural Gas G20 or 37mbar Propane G31 when set at high.

- ! IMPORTANT NOTE !** Ensure that the pressure test point used is sealed and gas tight.

22.2 - TESTING FOR SPILLAGE

- A restrictor will have already been fitted if deemed acceptable and effective height was greater than 3 meters.
The restrictor must not be fitted if the flue is a flexible liner is less than 3 meters of effective height and or as poor Draw.
- Once the fire is operational the installer must check for spillage. Close all doors and windows. Carry out the lighting procedure and turn the fire to high. Allow to warm up for 5 minutes and then using a lit smoke match, joss stick or similar, place centrally just under the edge of the inner lip of the baffle as shown below. The majority of the smoke must be drawn under into the Fire. Some small whiffs of smoke may be expelled and this is quite normal. Be careful not to introduce too much smoke (i.e. by using a pellet). A smoke match tube can be used to make holding of the match easier. See following diagram.

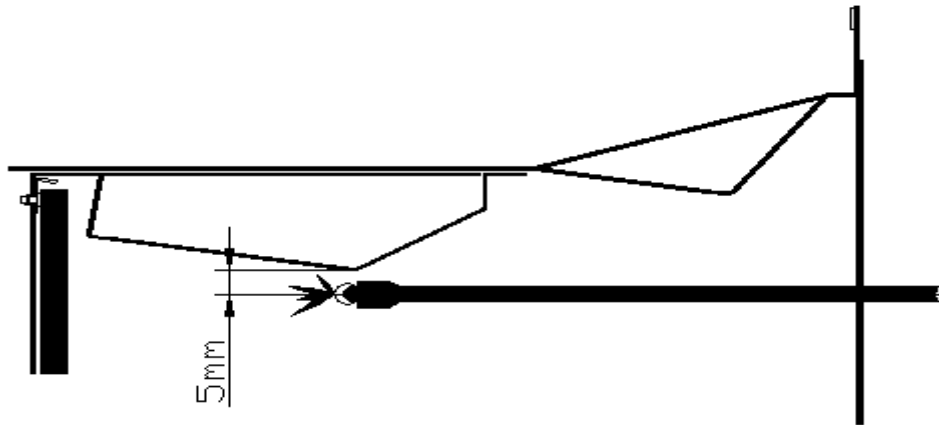

- Repeat the test with any doors to the room open, and with any extractor fans in the same room or adjacent rooms running at high. The fire should continue to clear its combustion products. Also operate any other flued appliance in the same or neighbouring rooms and ensure they continue to function satisfactorily as multiple flues can work against one another.
- If spillage is detected during this procedure, remove the restrictor (see below) if fitted and repeat the tests.
Removing the Restrictor.
 - To remove the Restrictor first allow the fire then remove the Baffle Assembly (3 fixing screws).
 - Now remove the 4 screws retaining the Restrictor plate then refit the Baffle Assembly.
- If spillage is detected and no restrictor is fitted, let the fire operate for a further 10 minutes and re-check.
- If the fire continues to spill, it could indicate a faulty flue or lack of ventilation. If the problem cannot be rectified immediately, disconnect the fire, affix a label and advise the customer not to use it until the problem has been resolved.
- g. It is an offence to use or allow the use of a dangerous appliance.**

22.3 - FITTING THE OUTER TRIM

- The Outer Trim is held in place with 4 strong Magnets, (8 Magnets with Grande Style Trim).
- Position the magnets one on each tab on the inside of the Trim (2 on each tab for the large Grande Trim Style).
- Locate the inner flange of the Trim on the inside of the fire and push into position so that the Magnets engage. Ensure the Trim is securely located on the fire.

22.4 - FIREGUARDS

- A fireguard is not supplied with the appliance however it is recommended that a fireguard conforming to BS 8423 is fitted if the fire is to be used in the presence of young children, the elderly, the infirm and pets.
- For Hole in the Wall fires it is recommended that a means, (tactile barrier /shelf or guard) is provided to give abrupt warning to a person moving inadvertently towards the fire.
Obviously care must be taken with loose fitting cloths when moving close to the fire.

23 - BRIEFING THE CUSTOMER

- a. The installer should brief the customer on the Operation of the Control System fitted (specifically the position for viewing the pilot for lighting, when applicable) and show them the relevant Section 2 for their reference in the future.
- b. Also brief the customer on how to turn the fire off with the Emergency Off Switch and ensure they also know the importance of pressing it back to the ' I ' position after using the switch otherwise the fire will not light.
- c. Demonstrate the sound that will be heard, (continuous high pitched bleep), if the switch is left in the ' 0 ' position indicating that the fire will not light.
- d. Explain to the Customers that the Batteries in the Handset and Battery Box in the fire will need changing as detailed below otherwise the fire may stop working part way through the season.

Changing Batteries

Dependant on usage the Handset batteries will require changing during an heating season.

- . The batteries in the Handset will need changing every 12months.
 - . The batteries in the Battery Box will need changing every 6months.
 - . Demonstrate to the customer how to gain access to the batteries specifically those in the Battery Box and show them the relevant Section 2 for their reference in the future.
 - . Stress the importance of replacing the batteries with good quality batteries.
- e. The customer should be briefed on the need for regular servicing; this will normally be once a year.
 - f. Advise the customer that, apart from the batteries there are no user replaceable parts in the fire but for servicing and spares to contact the local Nu-Flame Stockist.
 - g. Advise the customer that if any changes are made to the property that could affect ventilation to the room or house they should have the fires installation rechecked specifically the spillage assessment.
 - h. Explain to the Customer that during its first few days of use any protective coatings and oils will burn out of the fire creating an dour and this is quite normal.
 - i. Explain to the Customer that over time any wall coverings may discolour and this can be due to either the types of material used in the wall covering and or particles of dust being carried by the natural ventilation flowing around the room.
 - j. The Matrix Pieces in the fire are Moulded Ceramic Fibre component incorporating Silicone Binders and you may notice that over time they develop cracks during operation. This is natural shrinkage caused by exposure to high temperatures and is quite normal for the material and will in no way affect the operation of the fire.
 - k. The instructions should be handed to the customer for their safe keeping and future servicing.
 - l. Point out to the Customer that the fire will become very hot during operation and stress the importance of a Fireguard and specifically :
A fireguard is not supplied with the appliance however it is recommended that a fireguard conforming to BS 8423 is fitted if the fire is to be used in the presence of young children, the elderly, the infirm and pets.
 - m. Advise the customer about the importance of checking and maintaining the Carbon Monoxide Alarm safety device.

24. - SERVICING

The Matrix Pieces in the fire are Moulded Ceramic Fibre component incorporating Silicone Binders and you may notice that they develop cracks during operation. This is natural shrinkage caused by exposure to high temperatures and is quite normal for the material and will in no way affect the operation of the fire.

24.1 - GENERAL

Note: Servicing must be carried out by a registered installer.

- a. The firebox does not have to be removed for Servicing, however the Burner Tray Assembly may need to be removed.
- b. Check the operation and ignition of the fire before servicing.
- c. Ensure the fire is cold before proceeding.
- d. Lay a dust sheet on the floor before proceeding.
- e. For fires fitted with Trims pull off the Outer Trim/Frame, (Locate the 4 magnets - 8 magnets for the Grande Trim). Locate all the magnets are they are easily lost.
- f. Taking great care not to mark the liners, remove the Fuel Effect pieces making reference in reverse order to Section 20 (refer to which fuel pieces are fitted Wood, Pebbles or Coal and the 3 piece Matrixes).
(The presence of white marks and/or surface cracking/crazing on the Matrixes is quite normal.)
- g. Lift off the Fuel Tray after removing any lose fuel bed pieces on the corners of the Fuel Tray and ensuring the small Battery Box Grille at the left is found and retained.
- h. Unscrew the cover plate (1 screw) over the Isolation/pressure elbow at the right.
- i. Carry out a gas soundness test before servicing by connecting to the Inlet Pressure Point on the Isolation Elbow just revealed.
Note : It is now a good time to remove the fragile and expensive rear and side liners - see below.
- j. Slide out the left and right liners, (holes in the top rear corner provided to assist), and remove the Rear Liner placing in a safe area as it is both fragile and an expensive part.
- k. Remove the Baffle Assembly by removing the 3 screws at the front and lowering/sliding forward to disengage the rear tabs.
- l. Now disconnect the gas inlet pipe at the right.
- m. Now at the same side and using a small screw driver release the switch from its bracket. Pressing under the switch lift it upward from the bracket then release by passing the wires through the slot in the bracket to release.
- n. Working at the left side slide using the plastic lever lift up the Battery Box and disconnect the lead and retain.
- o. At the front lift the wires at both left and right of their retaining brackets and then lift out the Burner-Controls Assembly clear of the Burner Box Assembly.
- p. Now inside the Burner Box at the bottom right remove the 4 screws to gain access for debris build-up and removal.
- q. If any parts need replacement, use only genuine parts supplied by Nu-Flame Ltd. Some components may look similar to those used in other gas fire, but these are not necessarily the same due to performance variations and must not be used.

This applies particularly to the ODS Pilot, Gas Control System and Ceramics.

! TIP ! Being Magnetic The 4 (8 for Grande Trim), Trim Magnets can be easily misplaced,. Locate them immediately.

Remind the Customer that in the interests of Safety they MUST maintain their Carbon Monoxide Alarm

24.2 - ANNUAL SERVICING

Carry out the operations in 23.1 General before proceeding

! IMPORTANT NOTE ! TAKE GREAT CARE WHEN WORKING INSIDE THE FIRE NOT TO MARK THE CERAMIC LINING PANEL IF THEY HAVE NOT BEEN REMOVED.

- a. Checking in the opening of the Burner Box if a build-up of Debris is found that cannot be easily removed through the opening then the Battery Cassette and Burner Box will need to be removed, see below.
 - i. Working at the left side lift up the Battery Cassette Assembly by pulling upward on the tabs inside and set aside.
 - ii. Now to the right lift upward and remove the large Burner Box Assembly (complete with Burner Tray Assembly).
- b. Now remove any Debris and replace in reverse order ensuring that when the Battery Cassette Assembly is refitted the foam strip seals up against the side of the Burner Box.

Note: If the Debris volume indicates a flue problem then this should be corrected before continuing.
- c. Brush clean the burner and pilot area of dust or debris; check that the aeration hole in the pilot is clear of dust, fluff, lint.

Note : It is quite normal to see shrinkage cracks on the Burner Pad on the edges of the Flame Slots.
- d. Refit in reverse order brushing the fuel effect pieces clean of any soot, checking gas soundness, ignition and spillage as detailed in the relevant sections.

ALWAYS CONDUCT A GAS SOUNDNESS AND SPILLAGE CHECK AFTER SERVICING.

ALWAYS RESEAL THE PRESSURE TEST POINT AND CHECK THAT IT IS GAS TIGHT. (This accounts for a lot of recalls.)

ALWAYS CHECK THAT THE CONTROL SYSTEM IS WORKING CORRECTLY. (This accounts for a lot of recalls.)

25. - FAULT FINDING GUIDE, SYMPTOMS AND POSSIBLE CAUSES

FAULT FINDING ADVISE

Important : In instances where it is indicating that the main control system needs changing you should investigate returning the whole Burner Control Assembly to Nu-Flame for rectification as this could be the least cost option.

IGNITION SEQUENCE

Important : Prior to conducting any Fault Finding it is important to know the Ignition Sequence, see at which stage the sequence is failing and note the options that can be carried out. The sequence is as follows:

- a. After operating the Handset as detailed in Section 2 an audible ' clunk ' is heard indicating the Pilot Gas Solenoid as opened.
- b. The Pilot Igniter will then start to spark, followed by a pilot flame and the sparking will continue until the thermocouple as generated the electrical output required. This as a limited time so if the output is not sufficient the pilot solenoid will ' clunk ' shut. With new Installations or a Serviced fire there may be air in the gas pipeline affecting the Pilot Flame size. Repeat the operation.
- c. The Control Motor will then be heard turning the Control mechanism and when it reaches its maximum position you will hear another ' click ' indicating the main gas solenoid as opened and the main burner will light.

25.1 - GENERAL

- a. Prior to carrying out any of the following steps ensure that you have carried out the procedures in Section 23.1 General (Servicing) to the appropriate level as required.
- b. Check the supply pressure at the isolation elbow.
- c. **Important :** With the Thermatronic RF System always change the batteries before carrying out any Fault Finding.

It is important to know the ignition sequence prior to conducting any Fault Finding.

25.2 - RESETTING THE HANDSET (Every Handset as a unique code that the Receiver needs to learn)

- a. Replace the Batteries in both the Battery Box and Handset.
- b. Locate the Reset Hole on the side of the Receiver and using a pen press and hold in the Reset button until you hear two beeps. The first beep is short and the second beep is long. After the second beep release the Reset Button.
- c. Now on the Handset, within the next 20seconds press and hold down the small flame button until you hear two additional short beeps confirming the code is set in the Receiver. If you hear one long beep the Code as not been set so repeat the procedure.
- d. If the Handset still does not work then check the wiring and or replace the Receiver and Handset (if not a New Handset).

In instances where it is indicating that the some or all of main gas control system need changing you should discuss the situation with Nu-Flame's Service Department to determine the least cost option.

25.3 - NO SPARK IGNITION

- a. Replace the batteries in the Battery Box and Handset.
- b. Check that the Emergency Switch at the right is set at ' I ' . Then operate the switch a number of times before resetting.
- c. Check the position of the Radio Frequency Antenna, it should be pointing vertically upward.
- d. Check there is no dust/debris shorting out the electrode or blocking gas from the pilot.
- e. Check the condition of all leads specifically the Ignition lead and ensure it is connected securely to both the ignition electrode and the pilot Electrode.
- f. Check that the Ignition lead is not trapped and or shorting, replace if required.
- g. Check that gas is flowing from the pilot during the ignition sequence. Clean or Replace as required.
- h. Main Gas Control - listen to the control to hear if the pilot gas solenoid is opening. Change the Receiver, and the Handset at the same time and/or gas control. Refer to Diagram for Cable connections in Section 24.

25.4 - PILOT GOES OUT AFTER FIRST LIGHTING

- a. Check the steps a) to b) in the last Section 23:1.
- b. Check there is no debris blocking the flame to the thermocouple and that the flame is playing on the thermocouple. Change pilot as required.
- c. Check the thermocouple connections are tight.
- d. Change the pilot assembly as a new thermocouple may be required.
- e. Also see Section 23.4
- f. Change the Receiver, wiring and the Handset at the same time and/or the gas control.

Refer to Diagram for Cable connections on in Section 24.

In instances where it is indicating that the some or all of main gas control system need changing you should discuss the situation with Nu-Flame's Service Department to determine the least cost option.

25.5 - PILOT LIGHTS BUT MAIN BURNER DOES NOT LIGHT

- a. Main Gas Control - listen to the control to hear if the control motor is operating and if gas is flowing into the Burner. Change the Receiver, and the Handset at the same time and/or gas control. Refer to Diagram for Cable connections in Section 24.
- b. Check there is no dust or debris blocking the flame from the pilot to the main burner, and that the main burner cross lighting slot is clear of debris.
- c. Check if the main injector is blocked. Clean or Replace.

25.6 - PILOT FLAME SHORTENS, OR GOES OUT WHEN MAIN BURNER IS SELECTED

- a. Monitor the supply pressure at the isolation elbow as the main burner lights. If pressure drops, check gas pipe sizing, quality of pipe bending. Check for debris in the gas supply and or gas filter if fitted.
- b. Check that another appliance is not affecting the gas supply pressure.
- c. The Control System as a pressure test point under the outlet pipe leading to the injector. Check the Burner Pressure are as detailed in Section 6 Appliance Data. Ensure the test point is sealed off after checking. Check and change the main injector as required.
- d. Check for any signs of Debris in the gas supply line and also refer to Section 23.3.

25.7 - POOR FLAME PICTURE

- a. Check the supply pressure is correct at the isolation elbow. If the pressure is low, check gas pipe sizing, quality of pipe bending. Check for debris in the gas supply and or gas filter if fitted.
- b. The Control System as a pressure test point under the outlet pipe leading to the injector. Check the Burner Pressure are as detailed in Section 6 Appliance Data. Ensure the test point is sealed off after checking. Check and change the main injector as required.
- c. Check that another appliance is not affecting the gas supply pressure.
- d. Check there is not a flue/ventilation problem – carry out a spillage test.
- e. Check fuel bed layout as detailed in Section 20.

25.8 - FIRE OPERATES FOR A WHILE THEN GOES OUT

- a. Check the Section 23.4 first.
- b. Carry out a spillage test from cold. Look for signs of Discoloured Walls or Trims as this may be an indication of a Downdraught Problem resulting in the ODS pilot cutting out.
- c. Establish how long the fire stays alight then repeat the Spillage Test around this time.
- d. Check that the Pilot is functioning correctly as detailed in Section 23.2 and also check specifically the Thermocouple Electrical Connections and Pilot Flame size.

Downdraught problems can be related to the condition of the flue, chimney termination or geographical location; so if a Flue Problem is thought likely but no problem is found during the investigation isolate the fire and seek expert advice.

25.9 - THERMATRONIC RADIO REQUENCY CONTROL SYSTEM DOES NOT OPERATE

- a. Check the infrared control is being correctly operated - see Section 2.2.
- b. Check for error messages and check/change batteries - see Section 21 Ignition Sequence and Section 2.3.
- c. Reset the Mertik Maxitrol Logic Circuits - see Section 2.5.

ALWAYS CONDUCT A GAS SOUNDNESS AND SPILLAGE CHECK AFTER SERVICING.

ALWAYS RESEAL THE PRESSURE TEST POINTS YOU HAVE USED AND CHECK THAT THEY ARE GAS TIGHT. (This accounts for a lot of recalls.)

ALWAYS CHECK THAT THE CONTROL SYSTEM IS WORKING CORRECTLY. (This accounts for a lot of recalls.)

26a - ENERGY CLASS & PRODUCT FICHE - ICONA 600+ (Natural Gas) Models

Logs & Driftwood

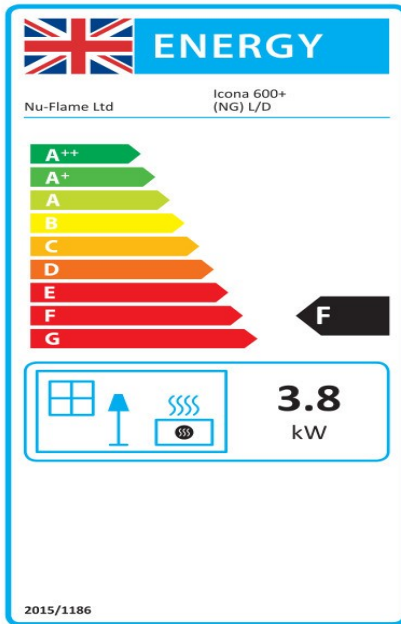

Supplier	Nu-Flame Limited
Model	Icona 600+ (NG) L/D
Energy Efficiency Class	F
Direct Heat Output	3.8kW
Energy Efficiency Index	46.0
Useful Energy Efficiency at Maximum	57.0%
Useful Energy Efficiency at Minimum	54.3%

The fire must be Installed & serviced by a properly qualified (in accordance with Local & National Codes) Installation Engineer and in accordance with these Installation Instructions

Pebbles

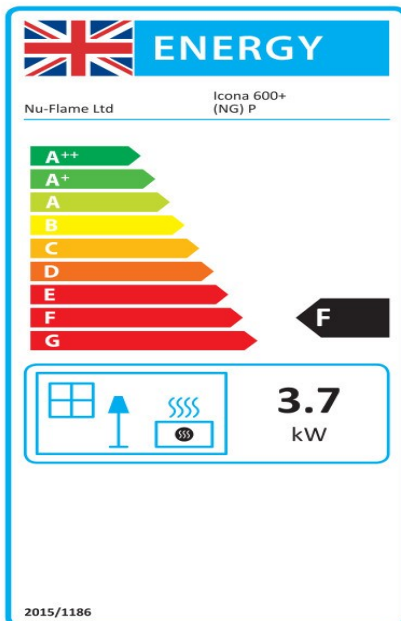

Supplier	Nu-Flame Limited
Model	Icona 600+ (NG) P
Energy Efficiency Class	F
Direct Heat Output	3.7kW
Energy Efficiency Index	45.3
Useful Energy Efficiency at Maximum	56.3%
Useful Energy Efficiency at Minimum	54.1%

The fire must be Installed & serviced by a properly qualified (in accordance with Local & National Codes) Installation Engineer and in accordance with these Installation Instructions

Coal

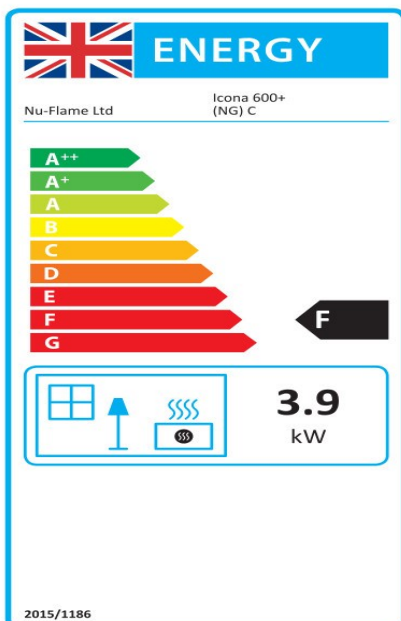

Supplier	Nu-Flame Limited
Model	Icona 600+ (NG) C
Energy Efficiency Class	F
Direct Heat Output	3.9kW
Energy Efficiency Index	47.9
Useful Energy Efficiency at Maximum	58.9%
Useful Energy Efficiency at Minimum	56.0%

The fire must be Installed & serviced by a properly qualified (in accordance with Local & National Codes) Installation Engineer and in accordance with these Installation Instructions

26b - ENERGY CLASS & PRODUCT FICHE - ICONA 600+ (Propane Gas) Models

Logs & Driftwood

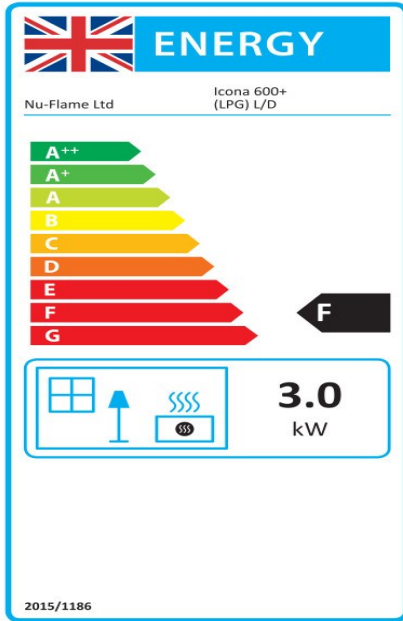

Supplier	Nu-Flame Limited
Model	Icona 600+ (LPG) L/D
Energy Efficiency Class	F
Direct Heat Output	3.0kW
Energy Efficiency Index	43.3
Useful Energy Efficiency at Maximum	54.3%
Useful Energy Efficiency at Minimum	51.3%

The fire must be Installed & serviced by a properly qualified (in accordance with Local & National Codes) Installation Engineer and in accordance with these Installation Instructions

Pebbles

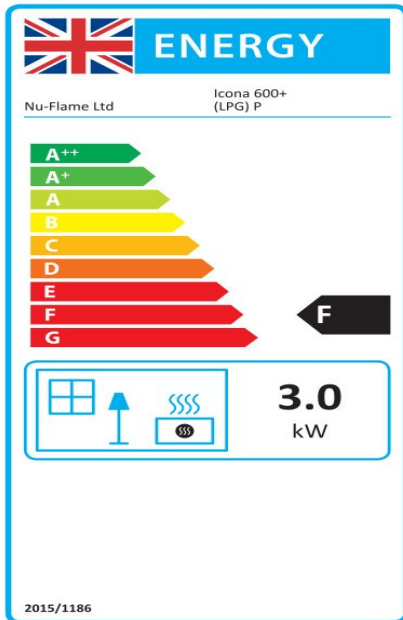

Supplier	Nu-Flame Limited
Model	Icona 600+ (LPG) P
Energy Efficiency Class	F
Direct Heat Output	3.0kW
Energy Efficiency Index	42.6
Useful Energy Efficiency at Maximum	53.6%
Useful Energy Efficiency at Minimum	50.5%

The fire must be Installed & serviced by a properly qualified (in accordance with Local & National Codes) Installation Engineer and in accordance with these Installation Instructions

Coal

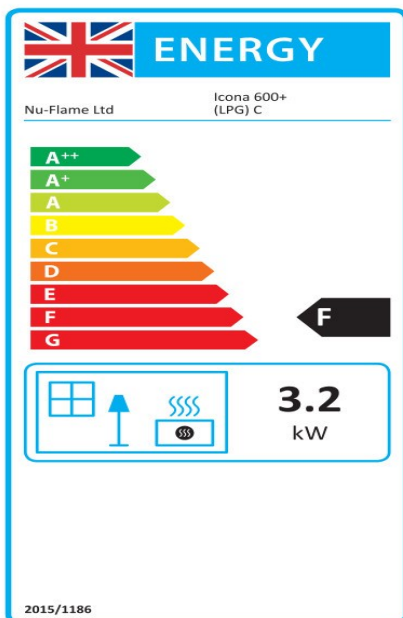

Supplier	Nu-Flame Limited
Model	Icona 600+ (LPG) C
Energy Efficiency Class	F
Direct Heat Output	3.2kW
Energy Efficiency Index	45.3
Useful Energy Efficiency at Maximum	56.3%
Useful Energy Efficiency at Minimum	53.1%

The fire must be Installed & serviced by a properly qualified (in accordance with Local & National Codes) Installation Engineer and in accordance with these Installation Instructions

26c - ENERGY CLASS & PRODUCT FICHE - ICONA 600+ (Natural Gas) Models

Logs & Driftwood

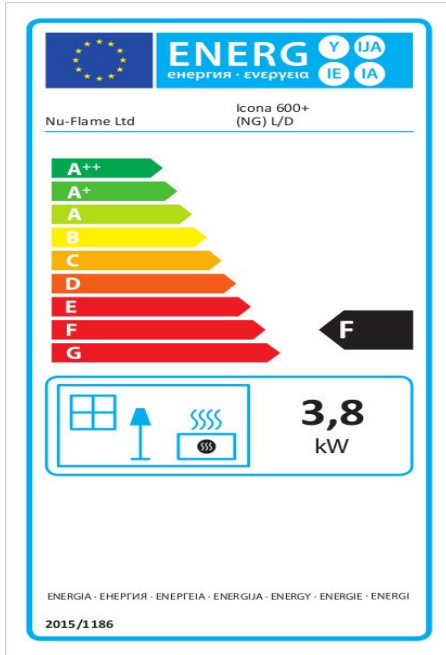

Supplier	Nu-Flame Limited
Model	Icona 600+ (NG) L/D
Energy Efficiency Class	F
Direct Heat Output	3.8kW
Energy Efficiency Index	46.0
Useful Energy Efficiency at Maximum	57.0%
Useful Energy Efficiency at Minimum	54.3%

The fire must be Installed & serviced by a properly qualified (in accordance with Local & National Codes) Installation Engineer and in accordance with these Installation Instructions

Pebbles

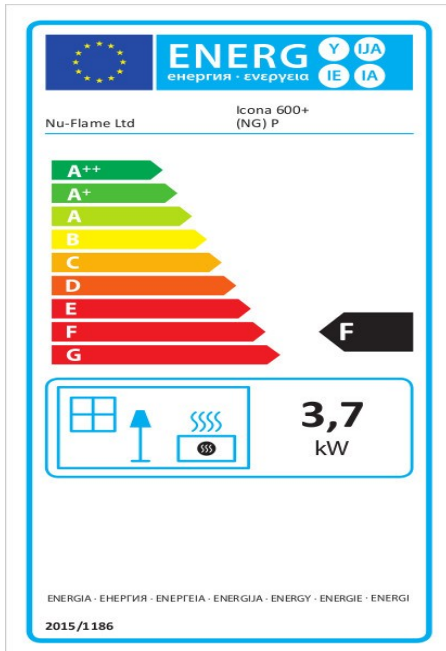

Supplier	Nu-Flame Limited
Model	Icona 600+ (NG) P
Energy Efficiency Class	F
Direct Heat Output	3.7kW
Energy Efficiency Index	45.3
Useful Energy Efficiency at Maximum	56.3%
Useful Energy Efficiency at Minimum	54.1%

The fire must be Installed & serviced by a properly qualified (in accordance with Local & National Codes) Installation Engineer and in accordance with these Installation Instructions

Coal

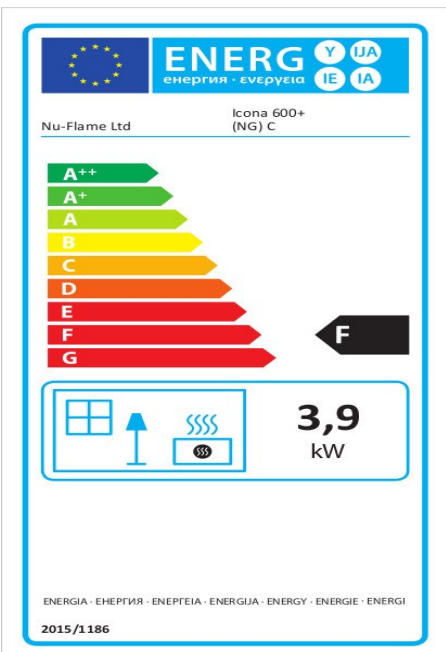

Supplier	Nu-Flame Limited
Model	Icona 600+ (NG) C
Energy Efficiency Class	F
Direct Heat Output	3.9kW
Energy Efficiency Index	47.9
Useful Energy Efficiency at Maximum	58.9%
Useful Energy Efficiency at Minimum	56.0%

The fire must be Installed & serviced by a properly qualified (in accordance with Local & National Codes) Installation Engineer and in accordance with these Installation Instructions

26d - ENERGY CLASS & PRODUCT FICHE - ICONA 600+ (Propane Gas) Models

Logs & Driftwood

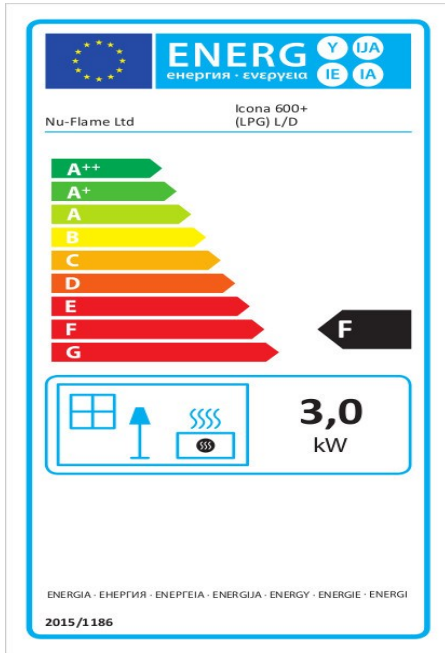

Supplier	Nu-Flame Limited
Model	Icona 600+ (LPG) L/D
Energy Efficiency Class	F
Direct Heat Output	3.0kW
Energy Efficiency Index	43.3
Useful Energy Efficiency at Maximum	54.3%
Useful Energy Efficiency at Minimum	51.3%
The fire must be Installed & serviced by a properly qualified (in accordance with Local & National Codes) Installation Engineer and in accordance with these Installation Instructions	

Pebbles

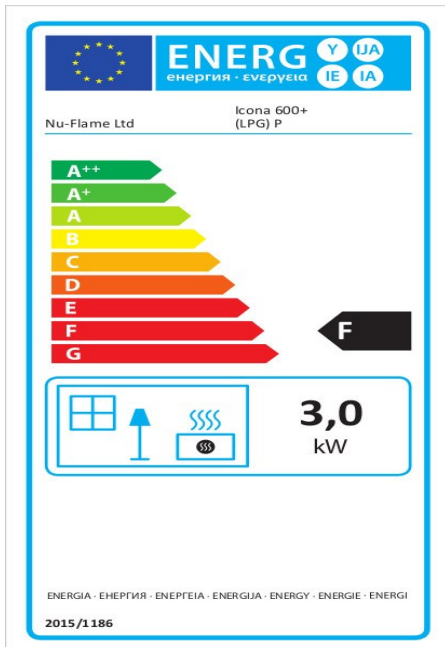

Supplier	Nu-Flame Limited
Model	Icona 600+ (LPG) P
Energy Efficiency Class	F
Direct Heat Output	3.0kW
Energy Efficiency Index	42.6
Useful Energy Efficiency at Maximum	53.6%
Useful Energy Efficiency at Minimum	50.5%
The fire must be Installed & serviced by a properly qualified (in accordance with Local & National Codes) Installation Engineer and in accordance with these Installation Instructions	

Coal

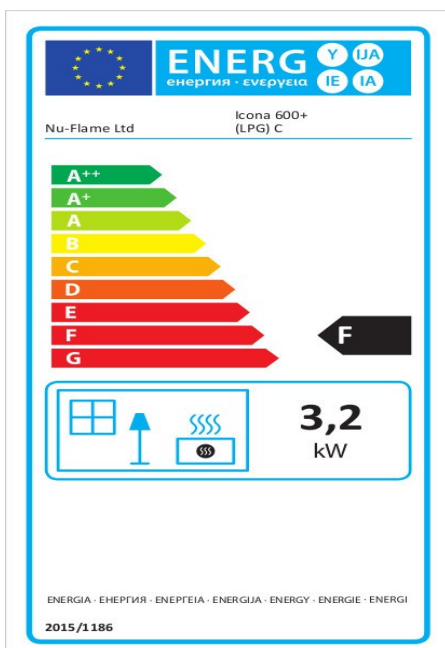

Supplier	Nu-Flame Limited
Model	Icona 600+ (LPG) C
Energy Efficiency Class	F
Direct Heat Output	3.2kW
Energy Efficiency Index	45.3
Useful Energy Efficiency at Maximum	56.3%
Useful Energy Efficiency at Minimum	53.1%
The fire must be Installed & serviced by a properly qualified (in accordance with Local & National Codes) Installation Engineer and in accordance with these Installation Instructions	

UK Declaration of Conformity

Name of the Client : Nu-Flame Ltd
Address of the Client : Unit 4
: Kimpton Trade & Business Centre
: Minden Road
: Sutton
: Surrey
: SM3 9PF

Telephone : 020 8641 9992

Manufacturing Location : As above

This declaration of conformity is issued under the sole responsibility of the manufacturer above for:

Product : Icona 600+

Certificate Number : UKCA 744503

The object of the declaration described above is in conformity with relevant harmonized legislation

Regulation 2016/426 on gas appliances as brought into UK law and amended.

The following harmonised standards and technical specification have been applied:

BS 7977-1: 2009 + A1: 2013 Specification for safety and rational use of energy of domestic gas appliances – Part 1: Radiant/convectors

Where the Essential Requirements of the GAR have been met and approved by Notified Body:

Responsible Test House : BSI Group
Address : Holywell Park
: Ashby Road
: Loughborough
: LE11 3AQ
: United Kingdom

Authorized Signature of Manufacturer:



Date of Issue: 19th April 2021

EU Declaration of Conformity

Name of the Client : Nu-Flame Ltd
Address of the Client : Unit 4
: Kimpton Trade & Business Centre
: Minden Road
: Sutton
: Surrey
: SM3 9PF

Telephone : 020 8641 9992

Manufacturing Location : As above

This declaration of conformity is issued under the sole responsibility of the manufacturer above for:

Product : Icona 600+

Certificate Number : CE688450

The object of the declaration described above is in conformity with relevant harmonized legislation

Gas Appliance Regulation (EU) 2016/426

The following harmonised standards and technical specification have been applied:

BS 7977-1: 2009 + A1: 2013 Specification for safety and rational use of energy of domestic gas appliances – Part 1: Radiant/convectors

Where the Essential Requirements of the GAR have been met and approved by Notified Body:

Responsible Test House : BSI Group
Address : Holywell Park
: Ashby Road
: Loughborough
: LE11 3AQ
: United Kingdom

Authorized Signature of Manufacturer:



Date of Issue: 21st April 2018



Telephone 020 8254 6802

Nu-Flame Warranty and Repair Procedure for The Icona 600+

Nu-Flame fires are guaranteed for 1 year from the date of purchase. During that time our guarantee is to repair at our option, or replace at no charge a fire that proves to have faulty components or workmanship.

Telephone Help Line. In the event of a problem with a fire the first course of action should be to telephone our technical department on 020 8254 6802 during normal working hours 9 - 5.30 Monday - Friday (closed 1 - 1.30). If appropriate this should be done before the installer leaves site as we may well be able to resolve the problem over the phone and in any event it may well save the installer a return visit to site. If we are not able to resolve the problem over the phone we may ask you to return the fire, and will log your details and give you a return reference number.

Returning the Fire and parts thereof. After assessment we might consider it best to return part of the appliance, such as the burner only, for testing. In this example the burner can then be thoroughly inspected and any signs of installation faults can be reported back to you. After any repair work is carried out the flow rates can be checked and re-set if necessary in order to fully comply with CE approval. **Note:** It is a condition of the warranty that you do not return any parts to us unless we request you to do so. For example if we request that the burner only is returned and you send the entire appliance, the fuel bed and other items could be damaged or lost during the return delivery to us. We will not be liable for any such breakages, or losses

Under no circumstances should any attempt be made to repair the burner on site without our express knowledge and approval during the warranty period.

This guarantee is given subject to the following provisions:

1. That the installation is carried out by a GAS SAFE registered installer (we may require their registration details).
2. That the appliance is installed and used in accordance with our Installation & User instructions.
3. That the gas supply pressure at the appliance is not more than 3mbar below the gas pressure stated on the data plate when the appliance is running on high flame, with any other major gas appliances also running.
4. That the fireplace and flue system conform to relevant local codes, building regulations and British Standards.
5. This Guarantee is not transferable and relates to the original installation only.
6. The appliance has not been subject to misuse or accident or been modified or repaired by any person other than the authorised employee or authorised representative of Nu-Flame Ltd.
7. The Record Data section on the front of the Installation & Servicing Instructions is to be completed on installation.
8. Nu-Flame Ltd accepts no liability for any consequential loss or damage arising from the use or failure of the product or any information provided, including, but not limited to, economic or financial loss, damage to peripheral equipment or products, loss of use, productivity or time.
9. That the serial no. data plate on the burner is intact.

This guarantee in no way reduces your statutory rights.

This guarantee supersedes any previously published guarantees.

Chargeable Repairs During And After The Warranty Period

If a repair is chargeable during the warranty period, due to installation faults we will inform you and where possible give you a quote, or if this is not possible, a price guide before starting work. We cannot always give a firm cost until we commence the repair as it is not always possible to tell which components have been damaged.